

# CHARLIE

## Pendant control station



Compact-sized pendant station for auxiliary control. Modern user-friendly design, developed by an industrial design firm on technical, anthropomorphic, futuristic and ergonomic specifications. Easy to handle and designed to reduce installation time and costs and maintenance down time.

### FEATURES

- Reduced time and costs for installation and wiring: the switches are assembled inside the pendant station without screws, with all the terminals facing the cable inlet and screws in the opposite direction to facilitate wiring.
- A threaded ring is used to secure the enclosure and cover, providing easy access to the internal components without any need for tools or screws.
- Thanks to the hollow handle the control station can be quickly and easily set down onto a pin.
- The emergency stop mushroom pushbutton complies with standard EN 418.
- Positive opening NC contacts for safety functions.
- Mechanical life of switches: 1 million operations.
- IP protection degree: Charlie is classified IP65.
- Extreme temperature resistance: -25°C to +70°C.
- All materials and components used are wear resistant and guarantee protection of the unit against water and dust.

### OPTIONS

- Available in configuration with 2 or 3 actuators.
- Single switches with NO or NC contacts and double switches with NO contacts, one or two speeds, with electrical interlock to prevent simultaneous operation of opposite functions.

### CERTIFICATIONS

- CE marking and EAC certification.

## CERTIFICATIONS

Conformity to Community Directives	2014/35/UE Low Voltage Directive
	2006/42/CE Machinery Directive
Conformity to CE Standards	EN 60204-1 Safety of machinery - Electrical equipment of machines
	EN 60947-1 Low-voltage switchgear and controlgear
	EN 60947-5-1 Low-voltage switchgear and controlgear - Control circuit devices and switching elements - Electromechanical control circuit devices
	EN 60529 Degrees of protection provided by enclosures
	EN 418 Safety of machinery - Emergency stop equipment, functional
Markings and homologations	CE EAC

## GENERAL TECHNICAL SPECIFICATIONS

Ambient temperature	Storage -40°C/+70°C
	Operational -25°C/+70°C
IP protection degree	IP 65
Insulation category	Class II
Cable entry	Cable clamp M20
	Spiral cable clamp M20
Operating positions	Any position
Weight	~ 320 g

## TECHNICAL SPECIFICATIONS OF THE MICROSWITCHES

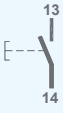
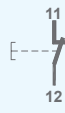
Code	PRSL1000PI	PRSL1001PI
Utilisation category	AC 15	
Rated operational current	3 A	
Rated operational voltage	250 Vac	
Rated thermal current	10 A	
Rated insulation voltage	500 Vac	
Mechanical life	1x10 <sup>6</sup> operations	
Connections	Screw-type terminal	
Wires	1x2.5 mm <sup>2</sup> , 2x1.5 mm <sup>2</sup> (UL - (c)UL: use 60°C or 75°C copper (CU) conductor and wire 16-18 AWG)	
Tightening torque	0.6 Nm	
Microswitch type	Double break, slow action	Double break, slow action
Contacts	1NO	1NC (All NC contacts are of the positive opening operation type  )
Scheme		
Markings and homologations	CE cULus EAC	

Code	PRSL1002PI	PRSL1003PI
Utilisation category	AC 15	
Rated operational current	3 A	
Rated operational voltage	250 Vac	
Rated thermal current	10 A	
Rated insulation voltage	500 Vac	
Mechanical life	1x10 <sup>6</sup> operations	
Connections	Screw-type terminal	
Wires	1x2.5 mm <sup>2</sup> , 2x1.5 mm <sup>2</sup> (UL - (c)UL: use 60°C or 75°C copper (CU) conductor and wire 16-18 AWG)	
Tightening torque	0.6 Nm	
Microswitch type	Double switch, one speed	Double switch, two speeds
Contacts	2NO+common	3NO+common
Scheme		
Markings and homologations	CE cULus EAC	

## TECHNICAL SPECIFICATIONS OF THE LAMP HOLDERS

Code	PRSL1004PI
Maximum voltage	125 V
Maximum power	2.6 W
Lamp type	T5.5K 22 mm
Connections	Screw-type terminal
Wires	1x2.5 mm <sup>2</sup> , 2x1.5 mm <sup>2</sup>
Tightening torque	0.6 Nm
Markings and homologations	CE

## OVERALL DIMENSIONS (mm)

With cable clamp M20

2

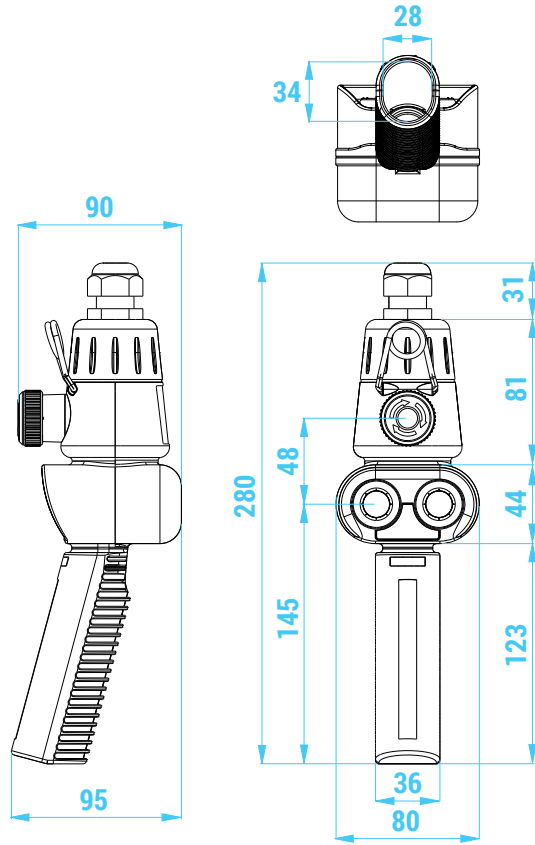

With spiral cable clamp M20

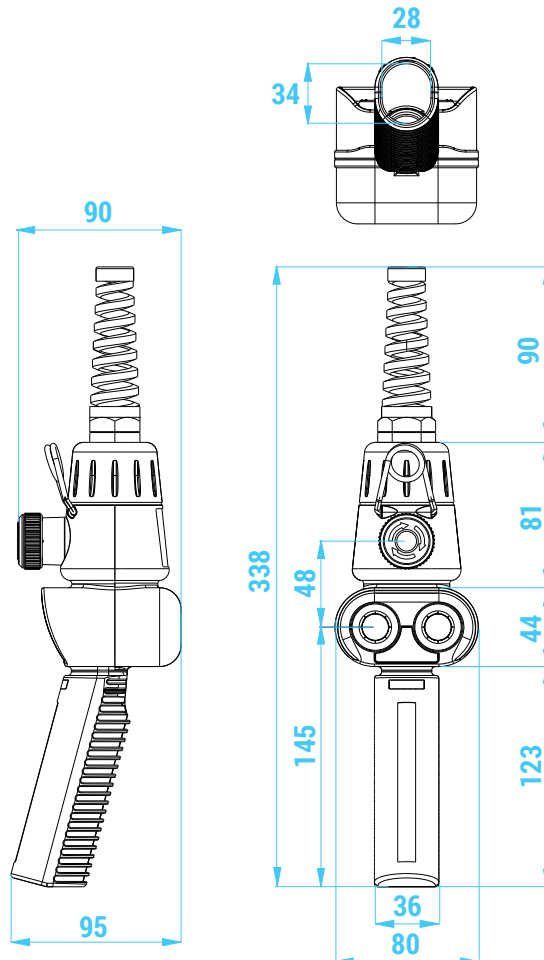

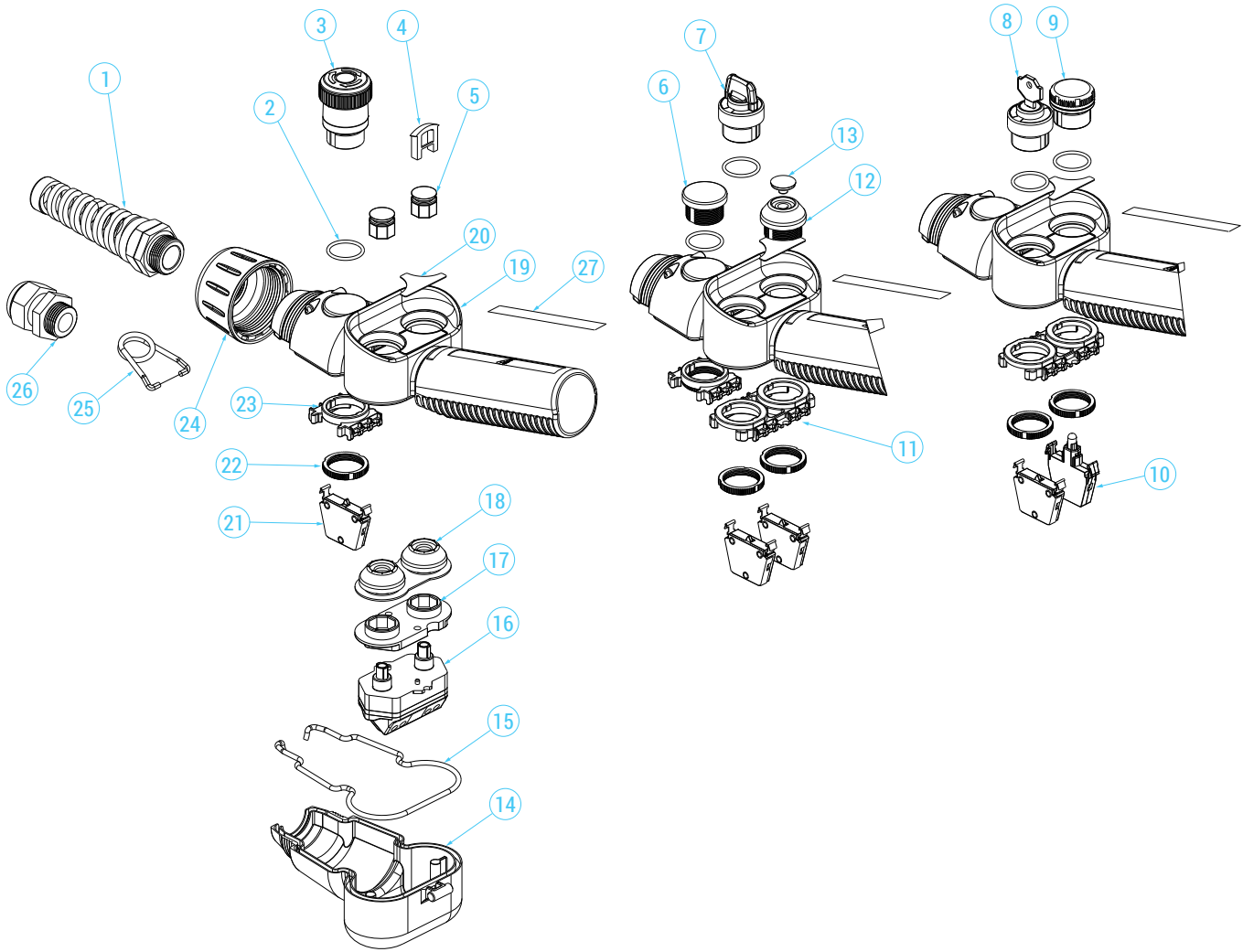

## STANDARD CONTROL STATIONS

Standard control stations are equipped with cable clamp M20, hook and electrical interlock between opposite function pushbuttons.

### 2 actuators

PF39020001			PF39020002		
Switch scheme	Switch type	Actuator type	Switch scheme	Switch type	Actuator type
	PRSL1002PI 2NO+common 1 speed	Pushbutton Pushbutton 		PRSL1003PI 3NO+common 2 speeds	Pushbutton Pushbutton 





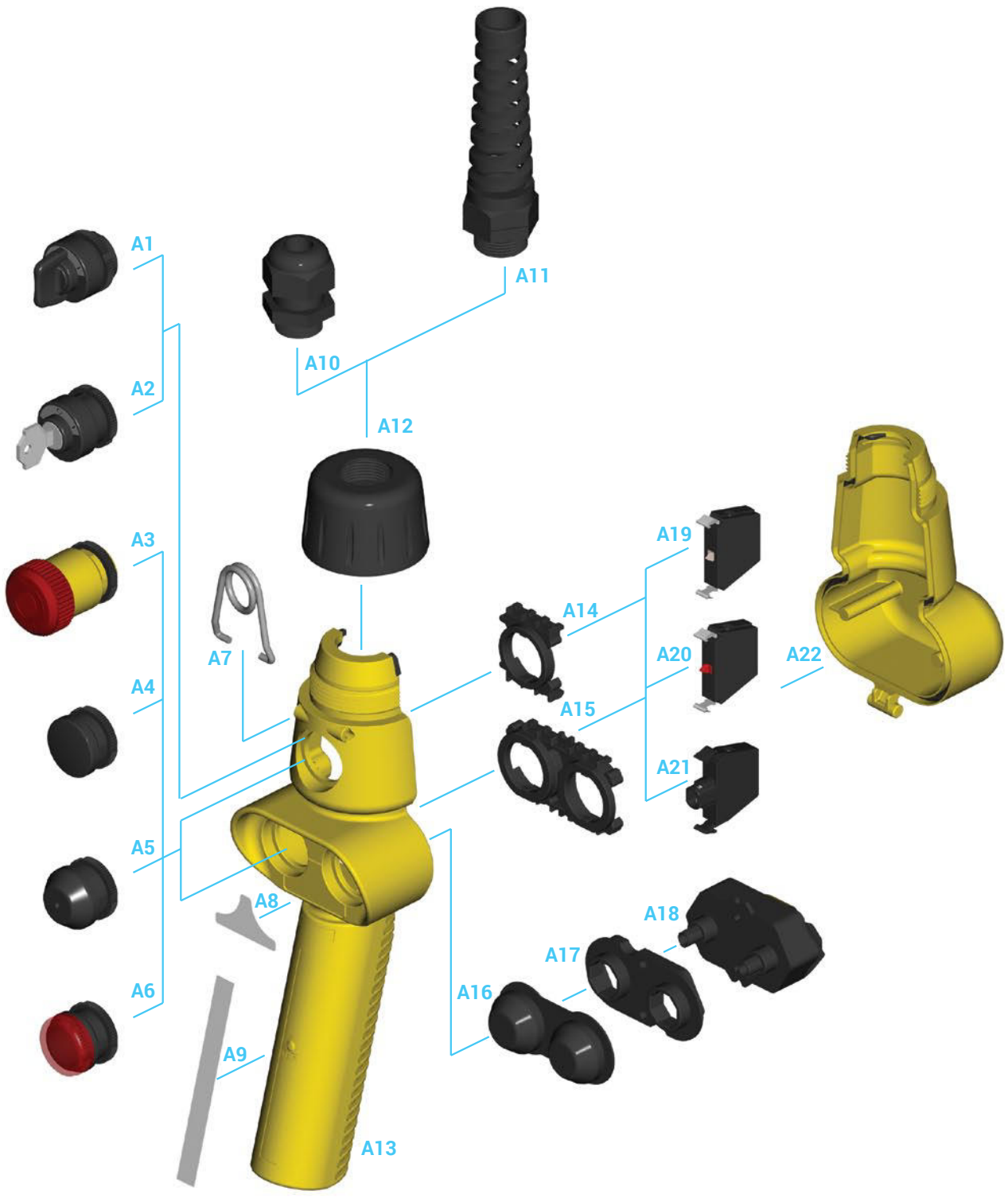

### 3 actuators

PF39030001			PF39030002		
Switch scheme	Switch type	Actuator type	Switch scheme	Switch type	Actuator type
	PRSL1001PI 1NC	Latched mushroom pushbutton		PRSL1001PI 1NC	Latched mushroom pushbutton
	PRSL1002PI 2NO+common 1 speed	Pushbutton Pushbutton 		PRSL1003PI 3NO+common 2 speeds	Pushbutton Pushbutton 

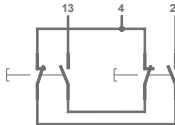
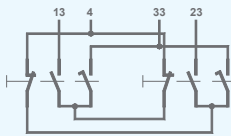





## COMPONENTS

## Switches

Ref.	Drawing	Description	Scheme	Code
A18		One speed, 1NO+1NO+common double switch		PRSL1002PI
		Two speeds, 3NO+common double switch		PRSL1003PI
A19		1NO single switch		PRSL1000PI
A20		1NC single switch		PRSL1001PI
A21		Lamp holder	-	PRSL1004PI

## Actuators

Ref.	Drawing	Description	Code
A4		Blanking plug	PRSL1023PI
A5		Single pushbutton	PRTS000001
A16		Double pushbutton	PRTD000001
A17		Holding plate for double pushbutton	PRSL8737PI

## Pilot lights



Ref.	Drawing	Color	Code
A6		Red	PRSL1012PI
		Yellow	PRSL1013PI
		Green	PRSL1014PI

## Mushroom pushbuttons













Ref.	Drawing	Description	Code
A3		Latched mushroom pushbutton for emergency stop	PRSL1009PI

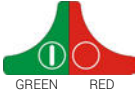

## Selector switches

Ref.	Drawing	Positions	Spring return	Maintained positions	Pull-out position	Code
A1		0/1	X			PRSL1015PI
		0/1		X		PRSL1016PI
		1/0/2	X			PRSL1026PI
		1/0/2		X		PRSL1027PI
A2		0/1		X	0	PRSL1017PI
		0/1	X		0	PRSL1024PI

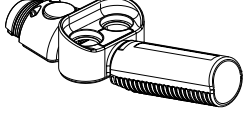
## Accessories

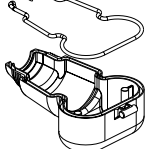
Ref.	Drawing	Description	Code
A7		Hook	PRGA0015PE
A8		Label	ET39030001
		Label	ET39030021
		Label	ET39030014
		Label	ET39030069
		Label	ET39030015
		Label	ET39030007
A9		TER label for handle	PRET0110PE
A10		Cable clamp M20	PRPS0064PE
A11		Spiral cable clamp M20	PRPS0025PE
A12		Closing ring for cable clamp and spiral cable clamp	PRSL5524PI
A13		Cover	PRSL5008PI
A14		Holding plate for 3 switches	PRSL8739PI
A15		Holding plate for 2+2 switches	PRSL8735PI
A22		Enclosure	PRSL5518PI

## CHARLIE - REQUEST FORM FOR NON STANDARD PENDANT STATION

### Control elements

- ① PRTS000001 Single pushbutton
- ② PRTD000001 Double pushbutton
- ③ PRSL1023PI Blanking plug
- ④ PRSL1009PI Emergency stop mushroom pushbutton
- ⑤ PRSL1012PI Red pilot light
- ⑥ PRSL1013PI Yellow pilot light
- ⑦ PRSL1014PI Green pilot light
- ⑧ PRSL1015PI Selector switch 0/1 spring return
- ⑨ PRSL1016PI Selector switch 0/1 maintained positions
- ⑩ PRSL1026PI Selector switch 1/0/2 spring return
- ⑪ PRSL1027PI Selector switch 1/0/2 maintained positions
- ⑫ PRSL1017PI Key selector switch 0/1 maintained positions
- ⑬ PRSL1024PI Key selector switch 0/1 spring return

### Label symbols

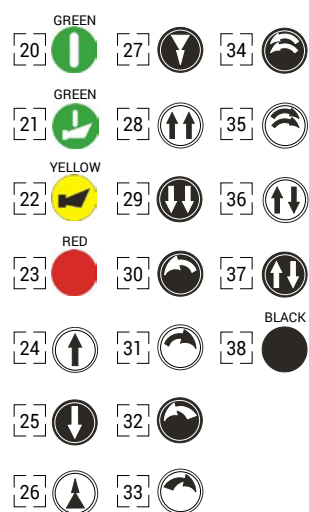

Cable clamp M20

Spiral cable clamp M20

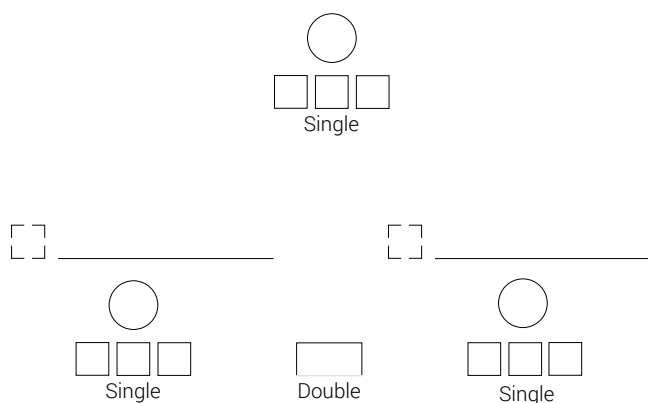

### Single switches

- |                            |            |             |
|----------------------------|------------|-------------|
| <input type="checkbox"/> A | PRSL1000PI | 1NO         |
| <input type="checkbox"/> B | PRSL1001PI | 1NC         |
| <input type="checkbox"/> C | PRSL1004PI | Lamp holder |

### Double switches

- |                            |            |          |
|----------------------------|------------|----------|
| <input type="checkbox"/> D | PRSL1002PI | 1 speed  |
| <input type="checkbox"/> E | PRSL1003PI | 2 speeds |

### Instructions

- Fill in the chart according to the number of control elements required.
- Write the number corresponding to the control element required in the circle. All selector switches can be assembled only in the central position.
- In the broken-line box write the number corresponding to the symbol required on the label. Next to the number mark the direction of the arrow and the customized lettering, if requested.
- In the unbroken box write the letter corresponding to the single or double switches.
- Tick the box if the cable clamp or the spiral cable clamp is required.
- The label on the handle of the control station can be customized on request: please write the text requested under Remarks or e-mail the logo.

### Remarks

---

---

---

---

---

---

---

---

---

---

---

---

---

---

---

---

---

---

---

---

---

## USE AND MAINTENANCE INSTRUCTIONS

*Charlie Pendant Control Station is an electromechanical device for low voltage control circuits (EN 60947-1, EN 60947-5-1) to be used as electrical equipment on machines (EN 60204-1) in compliance with the fundamental requirements of the Low Voltage Directive 2014/35/UE and of the Machine Directive 2006/42/CE.*

The pendant station is designed for industrial use and also for use under particularly severe climatic conditions (operational temperature from  $-25^{\circ}\text{C}$  to  $+70^{\circ}\text{C}$ , suitable for use in tropical environment). The equipment is not suitable for use in environments with potentially explosive atmosphere, corrosive agents or a high percentage of sodium chloride (saline fog). Oils, acids or solvents may damage the equipment; avoid using them for cleaning.

The switches (10, 16, 21)\* are designed for auxiliary control of contactors or electromagnetic loads (utilisation category AC-15 according to EN 60947-5-1). Do not connect more than one phase to each switch (10, 16, 21). Do not oil or grease the control elements (03, 05, 07, 08, 12) or the switches (10, 16, 21).

The installation of the pendant station shall be carried out by an expert and trained personnel. Wiring shall be properly done according to the current instructions.

Prior to the installation and the maintenance of the pendant station, the main power of the machinery shall be turned off.

### Steps for the proper installation of the pendant station

- Unscrew and remove the front ring (24) and the cable clamp (26).
- Open the lower cover (14).
- Insert the cable into the cable clamp (26) to a length suitable for wiring the switches.
- Strip the cable to a length suitable for wiring the switches (10, 16, 21).
- Tape the stripped part of the cable.
- Connect all the switches (10, 16, 21) according to the contact scheme printed on the switches (tighten the wires

into the terminals with a torque equal to 0.6 Nm (5.3 lbs/inch); insertability of wires into the switch terminals equal to  $2 \times 1.5 \text{ mm}^2 - 1 \times 2.5 \text{ mm}^2$  (UL (c)UL: use  $60^{\circ}\text{C}$  or  $75^{\circ}\text{C}$  copper (CU) conductors)).

- Screw the front ring (24) to close enclosure and lower cover (14) (check the proper positioning of the coupling pin of the lower cover (14) and of the rubber (15)).
- Tighten the cable clamp (26) on the cable tight enough to guarantee protection against water and/or dust.

### Periodic maintenance steps

- Check the proper tightening of the front ring (24).
- Check the proper tightening of the cable clamp (26).
- Check the proper tightening of the switch (10, 16, 21) terminal screws.
- Check all wiring (in particular where wires clamp into the switches).
- Check the conditions of the rubber (15) fit into the lower cover (14) and of the rubber of the control elements (12, 18).
- Check that the plastic enclosure (10, 05, 13) of the pendant station is not broken.

In case any component of the pendant station is modified, the validity of the markings and the guarantee on the equipment are annulled. Should any component need replacement, use original spare parts only.

TER declines all responsibility for damages caused by the improper use or installation of the equipment.

\* Please refer to the exploded drawing in the catalogue.