



Pendant station for auxiliary control of modern ergonomic shape, easy to handle, user friendly and sturdy.

Mike is the result of careful analysis of ergonomic aspects and it is rich in high-performing features to suit the most demanding requirements.

FEATURES

- Reduced installation and wiring time and costs: the cable inlet and the switches fitted in the base of the control station are separated from the actuators, installed on the cover.
- Innovative suspension system with concealed cables to enable rapid, correct, ergonomic installation.
- Rubber pushbuttons with symbol disks to ensure protection against dust and prevent jamming when the control station is used in harsh environments.
- The emergency stop mushroom pushbutton complies with standard ISO 13850.
- Positive opening NC contacts for safety functions.
- Mechanical life of pushbuttons and switches: 10 million operations.
- IP protection degree: Mike is classified IP66, IP67 and IP69K.
- NEMA protection degree: black Mike is classified Type 1, 4 and 4X*; yellow Mike is classified Type 1, 4 and 4X* for indoor use only.
- Extreme temperature resistance: -40°C to +80°C.
- All materials and components used are wear resistant and guarantee protection of the unit against water and dust.

OPTIONS



- Available in configuration from 4 to 15 actuators.
- Available with specific protection for actuators mounted on the bottom of the control station.
- 1NO or 1NC switches, LEDs voltage 24/48 Vac/dc or 110/230 Vac, and potentiometers.
- Mechanical interlock to prevent simultaneous operation of opposite functions.
- Wide range of actuators in different colours: one or two speed pushbuttons, selector switches and key-selector switches in various operation configurations, pilot lights, impulse or latched mushroom pushbuttons with rotation or key-operated release.
- One speed pushbuttons and selector switches available in illuminated version in a range of colours.
- Available with labels (symbols and lettering) to be applied next to the actuators or with pushbuttons with two-colour moulded permanent symbols.

CERTIFICATIONS

- CE marking, cULus* marking and EAC certification.
- Mike is available, upon request, with the SIL1 certification (Safety Integrity Level 1), according to Standard IEC61508.
- Complies with accident prevention regulation BGV C 1 (only for Germany).

* Not available on all versions.

CERTIFICATIONS







Conformity to Community Directives	2014/35/UE Low Voltage Directive
	2006/42/CE Machinery Directive
Conformity to CE Standards	EN 60204-1 Safety of machinery - Electrical equipment of machines
	EN 60947-1 Low-voltage switchgear and controlgear
	EN 60947-5-1 Low-voltage switchgear and controlgear - Control circuit devices and switching elements - Electromechanical control circuit devices
	EN 60947-5-5 Low-voltage switchgear and controlgear - Control circuit devices and switching elements - Electrical emergency stop device with mechanical latching function
	EN 60529 Degrees of protection provided by enclosures
Conformity to cULus Standards	ISO 13850 Safety of machinery - Emergency stop - Principles for design
	CSA-C22.2 No 14-13 Industrial Control Equipment
SIL1	UL 508 Industrial Control Equipment
	IEC 61508:2010 Part 2-4-6-7 Functional safety of electrical / electronic / programmable electronic safety-related systems
BGV C 1	Regulations for the prevention of accidents BGV C 1 (only for Germany)
Markings and homologations	  

GENERAL TECHNICAL SPECIFICATIONS





Ambient temperature	Storage -40°C/+80°C
	Operational -40°C/+80°C
IP protection degree	IP 66 / IP 67 / IP 69K
NEMA protection degree	Black Mike Type 1, 4 and 4X*
	Yellow Mike Type 1, 4 and 4X* indoor use only
Insulation category	Class II
Cable entry	Rubber cable sleeve (Ø 8÷26 mm)
	Cable clamp M20
Operating positions	Any position
Mechanical life	1 speed pushbutton: 10x10 ⁶ operations
	2 speed pushbutton: 10x10 ⁶ operations
	Illuminated pushbutton: 10x10 ⁶ operations

* Not available on all versions.

TECHNICAL SPECIFICATIONS OF THE MICROSWITCHES

Code	PRSL1800PI	PRSL1801PI
Utilisation category	AC 15	
Rated operational current	3 A	
Rated operational voltage	250 Vac	
Rated thermal current	10 A	
Rated insulation voltage	300 Vac	
Electrical Reliability EN 60947-5-4	$\lambda < 2.5 \times 10^{-8}$ at 24 V, 5 mA, 5×10^6 cycles	-
Mechanical life	10x10 ⁶ operations	
Connections	Screw-type terminal	
Wires	2x0.5mm ² - 2x1.5 mm ² - 1x2.5 mm ² (UL (c)UL: use 60°C or 75°C copper (CU) conductors and stiff or flexible wire 14-22 AWG)	
Tightening torque	0.5 Nm	
Microswitch type	Double break, slow action	
Contacts	1NO	1NC (All NC contacts are of the positive opening operation type )
Scheme		
Markings and homologations	  	

TECHNICAL SPECIFICATIONS OF THE LEDs

Code	PRSL1820PI	PRSL1821PI
Rated operational voltage	24-48 Vac/dc	110-240 Vac
Rated current consumption	1.30-2.70 mA	1.15-2.50 mA
Scheme		
Markings and homologations	  	

TECHNICAL SPECIFICATIONS OF THE POTENTIOMETERS

Code	PRVV9079PE	PRVV9019PE	PRVV9039PE
Ohmic value	1 k Ω	4.7 k Ω	10 k Ω
Life time	15x10 ³ movements (minimum)		
Operational ambient temperature	-25°C/+70°C		
Mechanical angle	300°		
Actual electrical angle	267°		
Ohmic value tolerance	±20%		

OVERALL DIMENSIONS (mm)

2

Standard

With small lower protection

With large lower protection

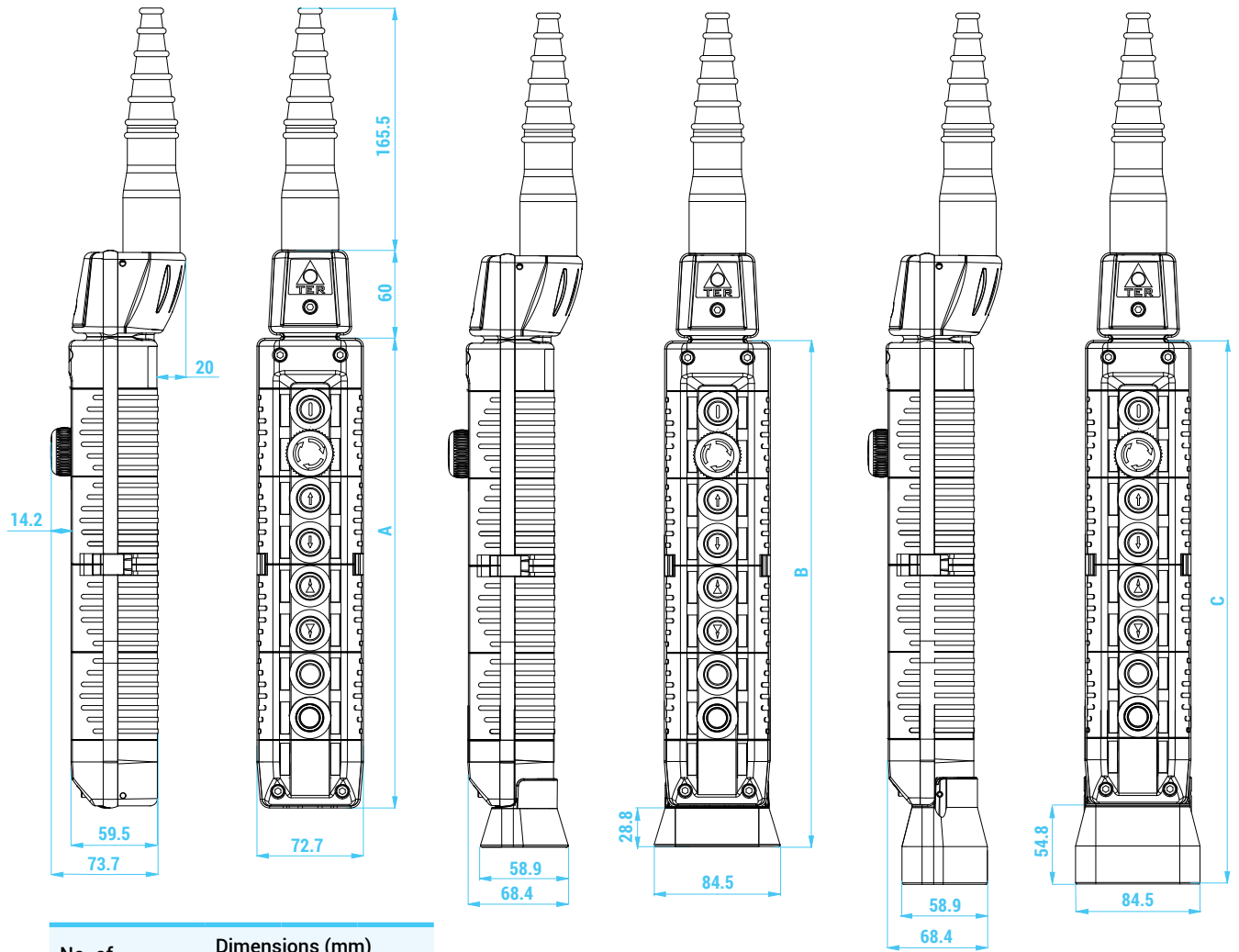

No. of actuators	Dimensions (mm)		
	A	B	C
4	201	229.8	255.8
5	201	229.8	255.8
6	261	289.8	315.8
7	261	289.8	315.8
8	321	349.8	375.8
9	321	349.8	375.8
12	441	469.8	495.8
13	441	469.8	495.8
14	501	529.8	555.8
15	501	529.8	555.8

Actuators

Key selector switches

Selector switches

Key mushroom pushbutton

Mushroom pushbutton Ø 40 mm

Potentiometer

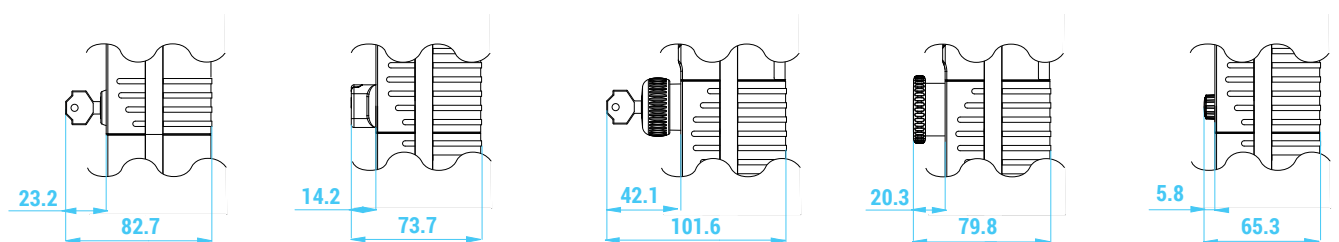

Dimensions of all mushroom pushbuttons refer to the released position.



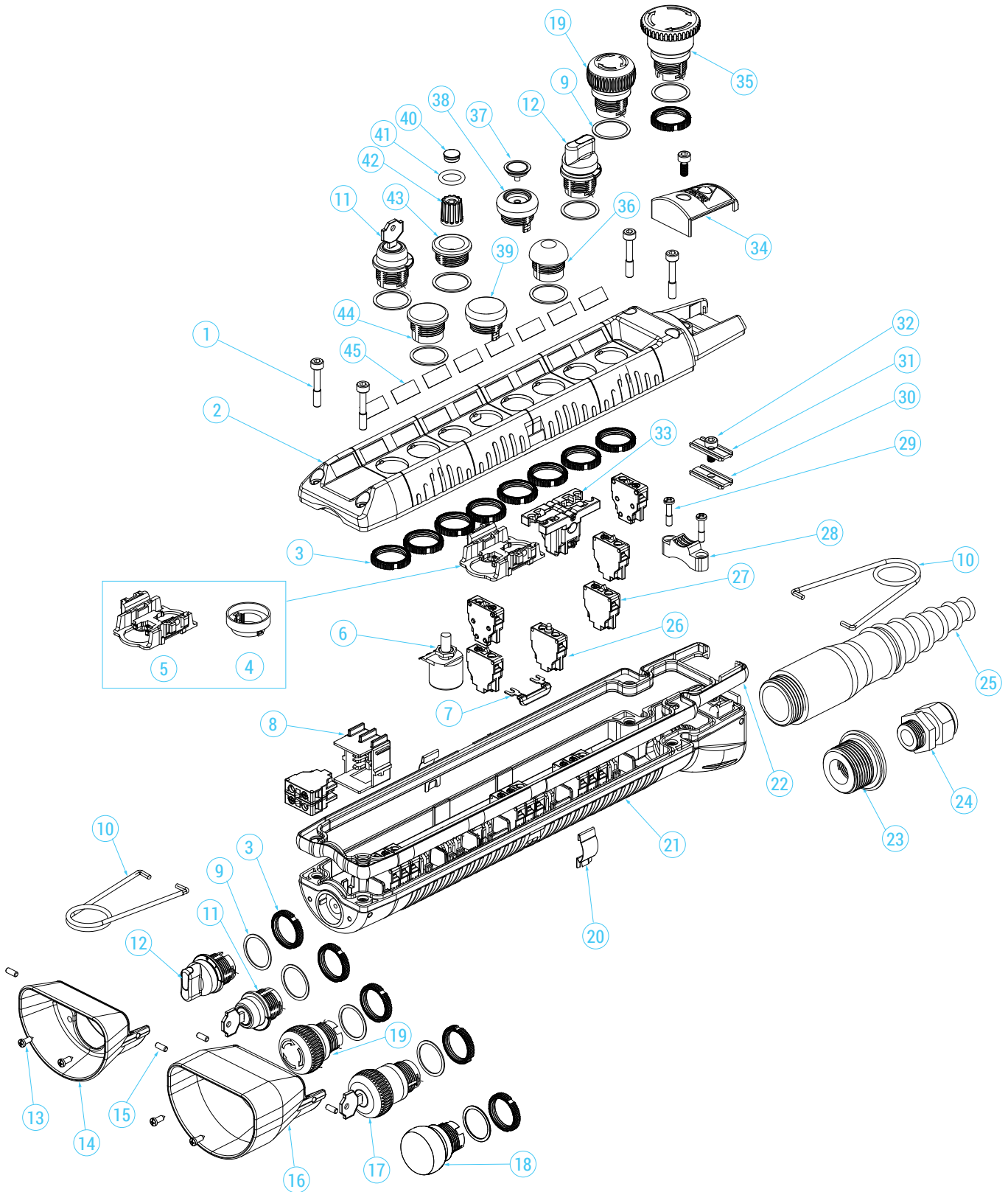





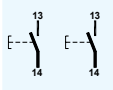

STANDARD CONTROL STATIONS

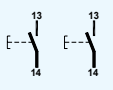
Standard control stations are supplied with symbol label sheet. Standard control stations are not cULus certified.

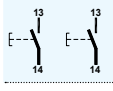

4 actuators

	Reset-Alarm button	Latched mushroom pushbutton	Black buttons mechanically interlocked between pairs		Cover color	Code
	No.2 PRSL1800PI 1NO+1NO	No.1 PRSL1801PI 1NC	No.1 PRSL1800PI 1NO	No.2 PRSL1800PI 1NO+1NO		
						
	1	1	2		Yellow	F70AY12020000001
	1	1	2		Black	F70AB12020000001
	1	1		2	Yellow	F70AY12000200001
	1	1		2	Black	F70AB12000200001

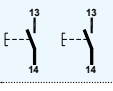

6 actuators

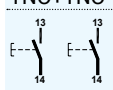
	Reset-Alarm button	Latched mushroom pushbutton	Black buttons mechanically interlocked between pairs		Cover color	Code
	No.2 PRSL1800PI 1NO+1NO	No.1 PRSL1801PI 1NC	No.1 PRSL1800PI 1NO	No.2 PRSL1800PI 1NO+1NO		
						
	1	1	4		Yellow	F70EY12040000002
	1	1	4		Black	F70EB12040000001
	1	1		4	Yellow	F70EY12000400002
	1	1		4	Black	F70EB12000400001

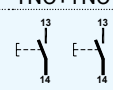

8 actuators

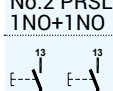
	Reset-Alarm button	Latched mushroom pushbutton	Black buttons mechanically interlocked between pairs		Cover color	Code
	No.2 PRSL1800PI 1NO+1NO	No.1 PRSL1801PI 1NC	No.1 PRSL1800PI 1NO	No.2 PRSL1800PI 1NO+1NO		
						
	1	1	6		Yellow	F70BY12060000001
	1	1	6		Black	F70BB12060000001
	1	1		6	Yellow	F70BY12000600001
	1	1		6	Black	F70BB12000600001

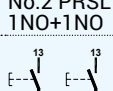
12 actuators

	Reset-Alarm button	Latched mushroom pushbutton	Black buttons mechanically interlocked between pairs		Cover color	Code
	No.2 PRSL1800PI 1NO+1NO	No.1 PRSL1801PI 1NC	No.1 PRSL1800PI 1NO	No.2 PRSL1800PI 1NO+1NO		
						
	1	1	10		Yellow	F70CY12100000001
	1	1	10		Black	F70CB12100000001
	1	1		10	Yellow	F70CY12001000001
	1	1		10	Black	F70CB12001000001

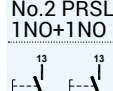

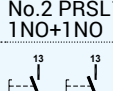

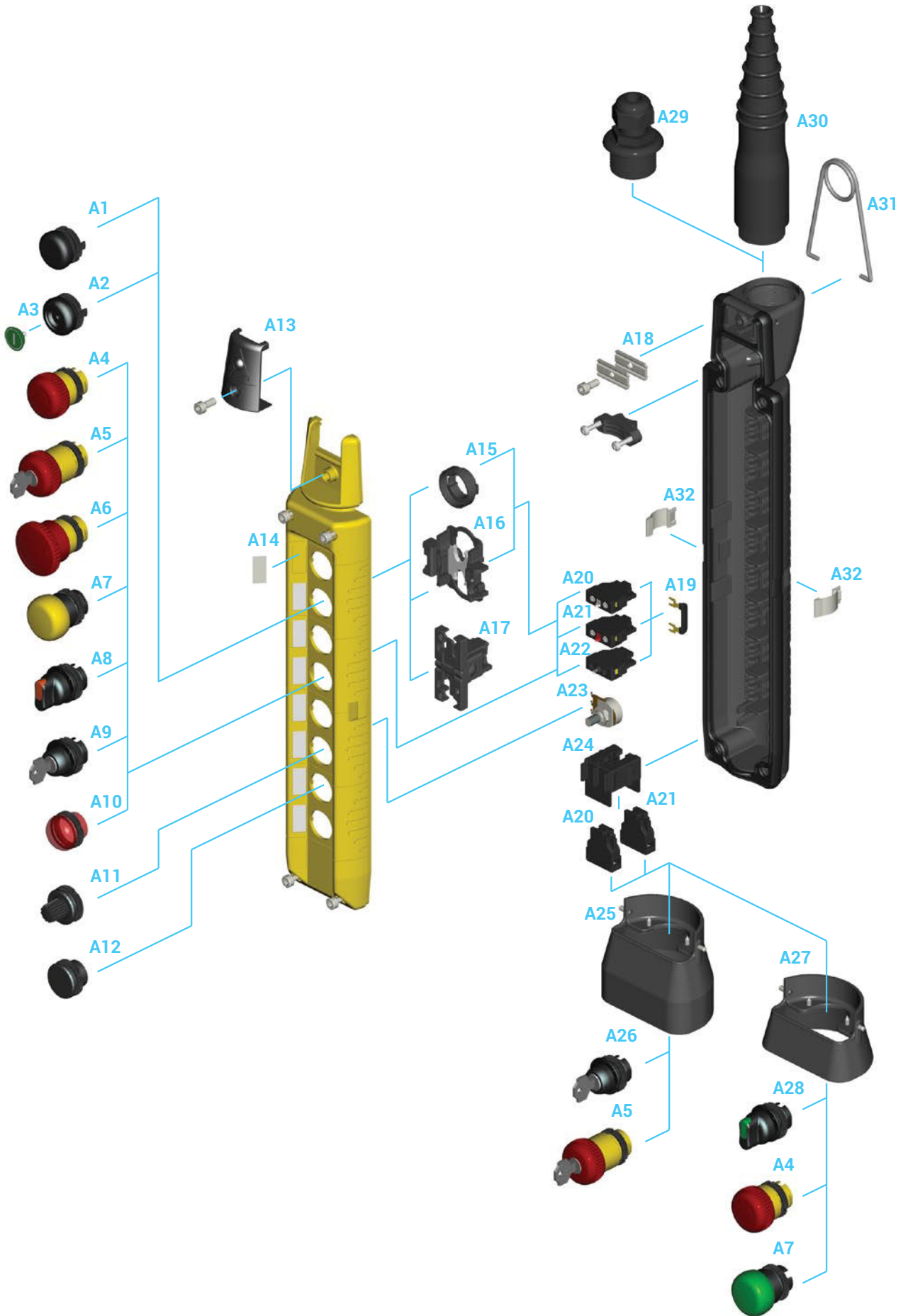

14 actuators

	Reset-Alarm button	Latched mushroom pushbutton	Black buttons mechanically interlocked between pairs		Cover color	Code
	No.2 PRSL1800PI 1NO+1NO	No.1 PRSL1801PI 1NC	No.1 PRSL1800PI 1NO	No.2 PRSL1800PI 1NO+1NO		
						
	1	1	12		Yellow	F70DY12120000001
	1	1	12		Black	F70DB12120000001
	1	1		12	Yellow	F70DY12001200001
	1	1		12	Black	F70DB12001200001



COMPONENTS





Switches

Ref.	Drawing	Description	Scheme	Code
A20		1NO switch		PRSL1800PI
A21		1NC switch		PRSL1801PI
A22		LED 24/48 Vac/dc		PRSL1820PI
		LED 110/230 Vac		PRSL1821PI

Potentiometers

Ref.	Drawing	Description	Code
A11 + A23		Potentiometer 4.7 kΩ	PRSL1891PI
		Potentiometer 10 kΩ	PRSL1892PI
		Potentiometer 1 kΩ	PRSL1893PI





Actuators

Ref.	Drawing	Description	Code
A1		1 speed black pushbutton	PRSL1806PI
		1 speed grey pushbutton	PRSL1807PI
		2 speed black pushbutton	PRSL1808PI
		2 speed grey pushbutton	PRSL1809PI
A2		2 speed pushbutton	PRSL1810PI
		1 speed pushbutton	PRSL1811PI
		1 speed illuminated pushbutton	PRSL1815PI
A3		Disk for pushbutton	PRTA_----- See disk table
A12		Blanking plug	PRSL1845PI
A17		Latched ON-OFF change-over actuator	PRSL1804PI



Pilot lights

Ref.	Drawing	Description	Code
A10		White	PRSL1844PI
		Green	PRSL1841PI
		Blue	PRSL1846PI
		Red	PRSL1840PI
		Yellow	PRSL1842PI
		Orange	PRSL1843PI

Mushroom pushbuttons



Ref.	Drawing	Description	Head color	Code
A4		Latched mushroom pushbutton for emergency stop	Red	PRSL1880PI
A5		Key mushroom pushbutton	Red	PRSL1890PI
A6		Latched mushroom pushbutton for emergency stop Ø 40 mm	Red	PRSL1881PI
A7		Impulse mushroom pushbutton Ø 33 mm with black base	Red	PRSL1885ROC
			Blue	PRSL1885BLC
			Yellow	PRSL1885GIC
			Green	PRSL1885VEC
			Orange	PRSL1885ARC
			Black	PRSL1885NEC

Key selector switches

Ref.	Drawing	Positions	Spring return	Maintained positions	Pull-out position	Code
A9 A26		0/1	X		0	PRSL1867PI
				X	0	PRSL1868PI
A9		1/0/2	X		0	PRSL1869PI
				X	0	PRSL1870PI
		0/1/1+2	X		0	PRSL1871PI
				X	0	PRSL1872PI
		1/2 change-over	X		1	PRSL1873PI
				X	1	PRSL1874PI
1/1+2/2	X		1+2	PRSL1875PI		
		X	1+2	PRSL1876PI		

Selector switches

2

Ref.	Drawing	Positions	Color		Code
			Trasparent	Full	
A8 A28		0/1 Spring return	White		PRSL1855BI
			Green		PRSL1855VE
			Blue		PRSL1855BL
			Red		PRSL1855RO
			Yellow		PRSL1855GI
			Orange		PRSL1855AR
		0/1 Maintained	White		PRSL1856BI
			Green		PRSL1856VE
			Blue		PRSL1856BL
			Red		PRSL1856RO
			Yellow		PRSL1856GI
			Orange		PRSL1856AR
		0/1 Spring return		White	PRSL1855BIC
				Green	PRSL1855VEC
				Blue	PRSL1855BLC
				Red	PRSL1855ROC
				Yellow	PRSL1855GIC
				Orange	PRSL1855ARC
		0/1 Maintained		White	PRSL1856BIC
				Green	PRSL1856VEC
	Blue		PRSL1856BLC		
	Red		PRSL1856ROC		
	Yellow		PRSL1856GIC		
	Orange		PRSL1856ARC		
A8		1/0/2 Spring return	White		PRSL1857BI
			Green		PRSL1857VE
			Blue		PRSL1857BL
			Red		PRSL1857RO
			Yellow		PRSL1857GI
			Orange		PRSL1857AR
		1/0/2 Maintained	White		PRSL1858BI
			Green		PRSL1858VE
			Blue		PRSL1858BL
			Red		PRSL1858RO
			Yellow		PRSL1858GI
			Orange		PRSL1858AR
		1/0/2 Spring return		White	PRSL1857BIC
				Green	PRSL1857VEC
				Blue	PRSL1857BLC
				Red	PRSL1857ROC
				Yellow	PRSL1857GIC
				Orange	PRSL1857ARC
		1/0/2 Maintained		White	PRSL1858BIC
				Green	PRSL1858VEC
	Blue		PRSL1858BLC		
	Red		PRSL1858ROC		
	Yellow		PRSL1858GIC		
	Orange		PRSL1858ARC		

Selector switches







Ref.	Drawing	Positions	Color		Code
			Trasparent	Full	
A8		1/1+2/2 Spring return	White		PRSL1863BI
			Green		PRSL1863VE
			Blue		PRSL1863BL
			Red		PRSL1863RO
			Yellow		PRSL1863GI
			Orange		PRSL1863AR
		1/1+2/2 Maintained	White		PRSL1864BI
			Green		PRSL1864VE
			Blue		PRSL1864BL
			Red		PRSL1864RO
			Yellow		PRSL1864GI
		1/1+2/2 Spring return		White	PRSL1863BIC
				Green	PRSL1863VEC
				Blue	PRSL1863BLC
				Red	PRSL1863ROC
				Yellow	PRSL1863GIC
		1/1+2/2 Maintained		White	PRSL1864BIC
				Green	PRSL1864VEC
				Blue	PRSL1864BLC
				Red	PRSL1864ROC
	Yellow		PRSL1864GIC		
0/1/1+2 Spring return		Orange	PRSL1864ARC		
	White		PRSL1859BI		
	Green		PRSL1859VE		
	Blue		PRSL1859BL		
	Red		PRSL1859RO		
	Yellow		PRSL1859GI		
0/1/1+2 Maintained	Orange		PRSL1859AR		
	White		PRSL1860BI		
	Green		PRSL1860VE		
	Blue		PRSL1860BL		
	Red		PRSL1860RO		
0/1/1+2 Spring return	Yellow		PRSL1860GI		
	Orange		PRSL1860AR		
		White	PRSL1859BIC		
		Green	PRSL1859VEC		
		Blue	PRSL1859BLC		
0/1/1+2 Maintained		Red	PRSL1859ROC		
		Yellow	PRSL1859GIC		
		Orange	PRSL1859ARC		
		White	PRSL1860BIC		
		Green	PRSL1860VEC		
0/1/1+2 Spring return		Blue	PRSL1860BLC		
		Red	PRSL1860ROC		
		Yellow	PRSL1860GIC		
		Orange	PRSL1860ARC		

Selector switches



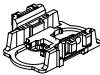

2

Ref.	Drawing	Positions	Color		Code
			Trasparent	Full	
A8		1/2. Spring return	White		PRSL1861BI
			Green		PRSL1861VE
			Blue		PRSL1861BL
			Red		PRSL1861RO
			Yellow		PRSL1861GI
			Orange		PRSL1861AR
		1/2. Maintained	White		PRSL1862BI
			Green		PRSL1862VE
			Blue		PRSL1862BL
			Red		PRSL1862RO
			Yellow		PRSL1862GI
		1/2. Spring return		White	PRSL1861BIC
				Green	PRSL1861VEC
				Blue	PRSL1861BLC
				Red	PRSL1861ROC
				Yellow	PRSL1861GIC
		1/2. Maintained		Orange	PRSL1861ARC
				White	PRSL1862BIC
				Green	PRSL1862VEC
				Blue	PRSL1862BLC
	Red		PRSL1862ROC		
	Yellow	PRSL1862GIC			
	Orange	PRSL1862ARC			

Accessories

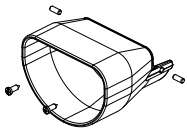
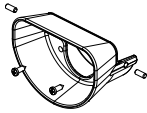
Ref.	Drawing	Description	Code
A13		Cable cover with TER logo	PRSL1832PI
		Blank cable cover	PRSL1836PI
A14		Label sheet - Symbols	PRET0215PE
		Label sheet - German	PRET0220DE
		Label sheet - English	PRET0220EN
		Label sheet - Spanish	PRET0220ES
		Label sheet - French	PRET0220FR
		Label sheet - Italian	PRET0220IT
A15		Button-switch spacer	PRSL8512PI
A16		Mechanical interlock	PRSL1850PI
A18		Complete wire clamp	PRSL1896PI
A19		Insulated connecting bridge - positions 3-4 (bag with 5 pieces)	PRSL1911PI
		Insulated connecting bridge - positions 2-4 (bag with 5 pieces)	PRSL1912PI
		Insulated connecting bridge - positions 1-4 (bag with 5 pieces)	PRSL1913PI
		Insulated connecting bridge - positions 1-3 (bag with 5 pieces)	PRSL1914PI
		Insulated connecting bridge - positions 1-2 (bag with 5 pieces)	PRSL1915PI
		Insulated connecting bridge - positions 1-2-3 (bag with 5 pieces)	PRSL1916PI
A24		1-2-3 switch holder	PRSL8750PI

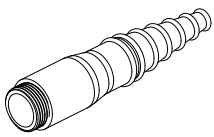
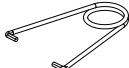
Accessories

Ref.	Drawing	Description	Code
A25		Large protection	PRSL1831PI
A27		Small protection	PRSL1830PI
A29		Cable clamp M20 with reduction	PRSL1910PI
A30		Cable sleeve	PRSL0145PE
A31		Hook	PRGA0012PE
A32		Closing clip	PRTR1035PE

Full color disks



Transparent disks



Label sheet - Symbols

2

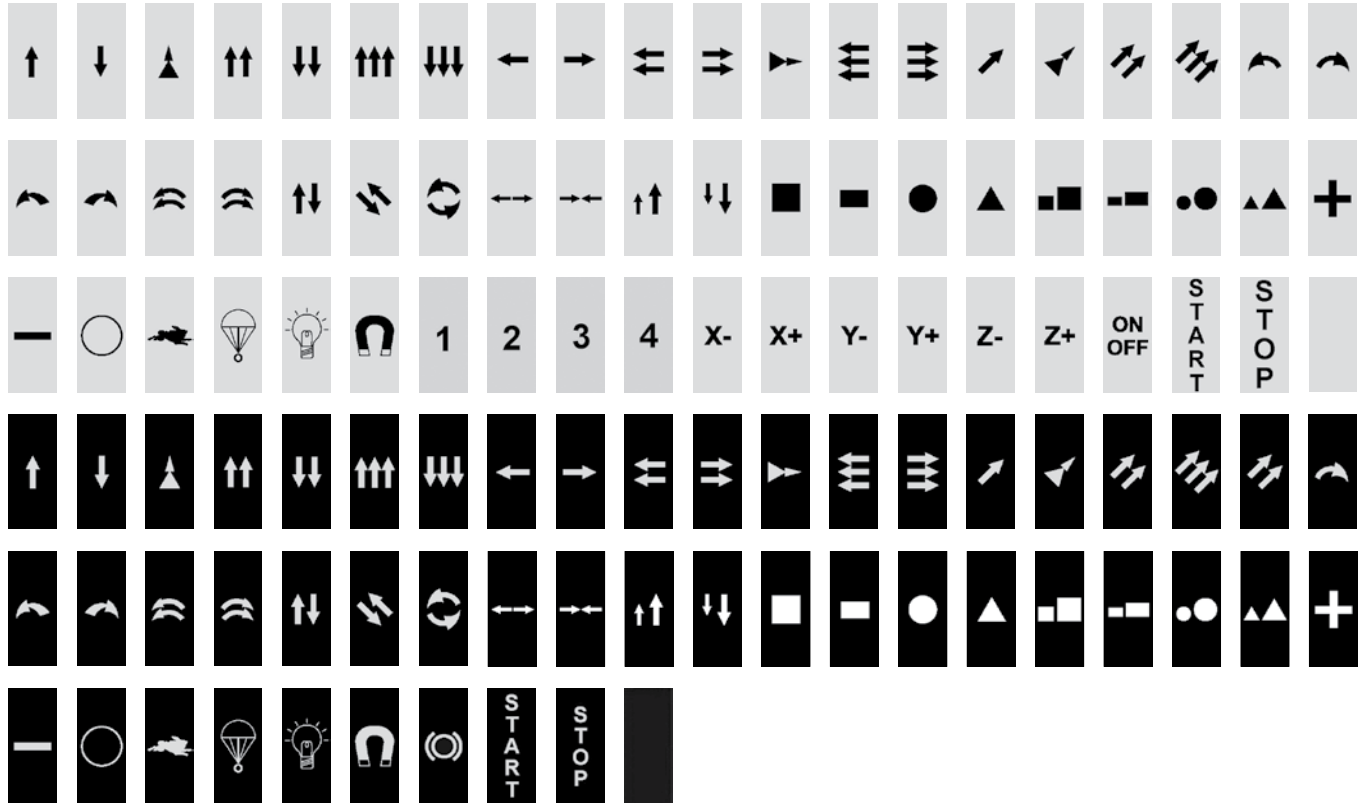

Label sheet - English

START	ALARM	RESET ALARM	RESET	STOP	LIGHT	RESET LINE	STOP LINE	START BUCKET	STOP BUCKET
BRAKE	BACK	UP	DOWN	UP LIFTING	DOWN LIFTING	UP LIFTING 1-2 SPEED	DOWN LIFTING 1-2 SPEED	UP LIFTING 3RD SPEED	DOWN LIFTING 3RD SPEED
UP LIFTING FAST	DOWN LIFTING FAST	LIFTING 2ND SPEED	LIFTING 3RDSPEED	UP AUXIL. LIFTING	DOWN AUXIL LIFTING	UP MAIN LIFTING	DOWN MAIN LIFTING	UP FAST MAIN LIFTING	DOWN FAST MAIN LIFTING
UP AUXIL. LIFTING 1-2 S.	DOWN AUXIL. LIFTING 1-2 S.	UP MAIN LIFTING 1-2 S.	DOWN MAIN LIFTING 1-2 S.	UP WINCH	DOWN WINCH	UP WINCH 1-2 SPEED	DOWN WINCH 1-2 SPEED	UP FAST WINCH	DOWN FAST WINCH
UP SLOW RIGHT WINCH	DOWN SLOW RIGHT WINCH	UP FAST RIGHT WINCH	DOWN FAST RIGHT WINCH	UP SLOW LEFT WINCH	UP FAST LEFT WINCH	DOWN FAST LEFT WINCH	UP HOIST	DOWN HOIST	UP HOIST 1-2 SPEED
DOWN HOIST 1-2 SPEED	UP FAST HOIST	DOWN FAST HOIST	FORWARD	BACKWARD	FORWARD TROLLEY	BACKWARD TROLLEY	FORWARD FAST TROLLEY	BACKWARD FAST TROLLEY	FORWARD TROLLEY 1-2 S.
BACKWARD TROLLEY 1-2 S.	FORWARD BRIDGE	BACKWARD BRIDGE	FORWARD FAST BRIDGE	BACKWARD FAST BRIDGE	FORWARD BRIDGE 1-2 S.	BACKWARD BRIDGE 1-2 S.	FORWARD TRANSLATION	BACKWARD TRANSLATION	LEFT
RIGHT	LEFT TROLLEY	RIGHT TROLLEY	LEFT FAST TROLLEY	RIGHT FAST TROLLEY	LEFT TROLLEY 1-2 S.	RIGHT TROLLEY 1-2 S.	LEFT BRIDGE	RIGHT BRIDGE	LEFT FAST BRIDGE
DOWN SLOW LEFT WINCH	RIGHT FAST BRIDGE	LEFT BRIDGE 1-2 S.	RIGHT BRIDGE 1-2 S.	CCW ROTATION	CW ROTATION	CCW FAST ROTATION	CW FAST ROTATION	CCW ROTATION 1-2 S.	CW ROTATION 1-2 S.
CCW ROTATION 3RD SPEED	CW ROTATION 3RD SPEED	LEFT CTRL STATION	RIGHT CTRL STATION	TROLLEY LEFT	TROLLEY RIGHT	SLOW	FAST	FAST TROLLEY	FAST BRIDGE
FAST LIFTING	FAST ROTATION	WINCH MATCHING	OPEN	CLOSE	OPEN GRAPPLE	CLOSE GRAPPLE	OPEN BUCKET	CLOSE BUCKET	OPEN DOOR
CLOSE DOOR	SPEED UP	SPEED DOWN	RAISE	LOWER	LOAD	DOWNLOAD	ENERGIZE	DE-ENERGIZE	ENERGIZE MAGNET
DE-ENERGIZE MAGNET	APPROACH	CONSENT	AUTOMATIC	MANUAL	MAN-0-AUTO	OFF-MAN-AUTO	ON	OFF	ON-OFF
IN	OUT	NORTH	SOUTH	EAST	WEST	OVERLOAD	TARE	1-1+2-2	1-2-1+2
1+2	ON-OFF	A-A+B-B							



Label sheet - Italian

MARCIA	ALLARME	MARCIA ALLARME	ARRESTO	STOP	LUCE	MARCIA LINEA	ARRESTO LINEA	MARCIA BENNA	ARRESTO BENNA
FRENO	RITORNO	SALITA	DISCESA	SALITA SOLLEV.	DISCESA SOLLEV.	SALITA SOLL. 1-2 VEL.	DISCESA SOLL. 1-2 VEL.	SALITA SOLL. 3a VEL.	DISCESA SOLL. 3a VEL.
SALITA SOLL. VEL.	DISCESA SOLL. VEL.	2a VELOCITÀ SOLLEV.	3a VELOCITÀ SOLLEV.	SALITA SOLL. AUSILIARIO	DISCESA SOLL. AUSILIARIO	SALITA SOLL. PRINCIPALE	DISCESA SOLL. PRINCIPALE	SALITA SOLL. PRINCIP. VEL.	DISCESA SOLL. PRINCIP. VEL.
SALITA AUSIL. 1-2 V.	DISCESA AUSIL. 1-2 V.	SALITA PRINCIP. 1-2 V.	DISCESA PRINCIP. 1-2 V.	SALITA ARGANO	DISCESA ARGANO	SALITA ARGANO 1-2 V.	DISCESA ARGANO 1-2 V.	SALITA ARGANO VEL.	DISCESA ARGANO VEL.
ARGANO DX SALITA LENTA	ARGANO DX DISC. LENTA	ARGANO DX SALITA VEL.	ARGANO DX DISCESA VEL.	ARGANO SIN SALITA LENTA	ARGANO SIN SALITA VEL.	ARGANO SIN DISCESA VEL.	SALITA PARANCO	DISCESA PARANCO	SALITA PAR. 1-2 V.
DISCESA PAR. 1-2 V.	SALITA PAR. VEL.	DISCESA PAR. VEL.	AVANTI	INDIETRO	AVANTI CARRELLO	INDIETRO CARRELLO	AVANTI CARR. VEL.	INDIETRO CARR. VEL.	AVANTI CARR. 1-2 V.
INDIETRO CARR. 1-2 V.	AVANTI PONTE	INDIETRO PONTE	AVANTI PONTE VEL.	INDIETRO PONTE VEL.	AVANTI PONTE 1-2 V.	INDIETRO PONTE 1-2 V.	AVANTI TRASLAZIONE	INDIETRO TRASLAZIONE	SINISTRA
DESTRA	SINISTRA CARRELLO	DESTRA CARRELLO	SINISTRA CARR. VEL.	DESTRA CARR. VEL.	SINISTRA CARR. 1-2 V.	DESTRA CARR. 1-2 V.	SINISTRA PONTE	DESTRA PONTE	SINISTRA PONTE VEL.
ARGANO SIN DISC. LENTA	DESTRA PONTE VEL.	SINISTRA PONTE 1-2 V.	DESTRA PONTE 1-2 V.	SINISTRA ROTAZIONE	DESTRA ROTAZIONE	SINISTRA ROTAZ. VEL.	DESTRA ROTAZ. VEL.	SINISTRA ROTAZ. 1-2 V.	DESTRA ROTAZ. 1-2 V.
SINISTRA ROTAZ. 3a V.	DESTRA ROTAZ. 3a V.	SINISTRA PULSANTIERA	DESTRA PULSANTIERA	CARRELLO SINISTRO	CARRELLO DESTRO	LENTO	VELOCE	VELOCE CARRELLO	VELOCE PONTE
VELOCE SOLLEV.	VELOCE ROTAZIONE	ACCOPIAMENTO ARGANO	APRE	CHIUDE	APRE PINZA	CHIUDE PINZA	APRE BENNA	CHIUDE BENNA	APERTURA PORTELLO
CHIUSURA PORTELLO	ACCELERA	DECELERA	ALZA	ABBASSA	CARICO	SCARICO	ECCITA	DISECCITA	ECCITA MAGNETE
DISECCITA MAGNETE	ACCOSTA	CONSENSO	AUTOMATICO	MANUALE	MAN-0-AUTO	OFF-MAN-AUTO	ON	OFF	ON-OFF
IN	OUT	NORD	SUD	EST	OVEST	SOVRACCARICO	TARA	1-1+2-2	1-2-1+2
1+2	ON-OFF	A-A+B-B							

Label sheet - French

MARCHE	ALARME	MARCHE ALARME	RESET	ARRET	LUMIERE	MARCHE LIGNE	ARRET LIGNE	MARCHE BENNE	ARRET BENNE
FREIN	RETOUR	MONTEE	DESCENTE	MONTEE LEVAGE	DESCENTE LEVAGE	MONTEE LEV. 1-2 VIT.	DESCENTE LEV. 1-2 VIT.	MONTEE LEV. 3EME VIT.	DESCENTE LEV. 3EME VIT.
MONTEE LEV. VITE	DESCENTE LEV. VITE	MONTEE LEV. 2EME VIT.	DESCENTE LEV. 3EME VIT.	MONTEE LEV. AUXILIAIRE	DESCENTE LEV. AUXILIAIRE	MONTEE LEV. PRINCIPAL	DESCENTE LEV. PRINCIPAL	MONTEE LEV. PRINC. VITE	DESCENTE LEV. PRINC. VITE
MONTEE LEV. AUX. 1-2 VIT.	DESCENTE LEV. AUX. 1-2 VIT.	MONTEE LEV. PRINC. 1-2 VIT.	DESCENTE LEV. PRINC. 1-2 VIT.	MONTEE TREUIL	DESCENTE TREUIL	MONTEE TREUIL 1-2 VIT.	DESCENTE TREUIL 1-2 VIT.	MONTEE TREUIL VITE	DESCENTE TREUIL VITE
TREUIL DROITE MONTEE LENTE	TREUIL DROITE DESC. LENTE	TREUIL DROITE MONTEE VITE	TREUIL DROITE DESCENTE VITE	TREUIL AUCHE MONTEE LENTE	TREUIL AUCHE MONTEE VITE	TREUIL AUCHE DESCENTE VITE	MONTEE PALAN	DESCENTE PALAN	MONTEE PALAN 1-2 VIT.
DESC. PALAN 1-2 VIT.	MONTEE PALAN VITE	DESCENTE PALAN VITE	AVANT	ARRIERE	AVANT CHARIOT	ARRIERE CHARIOT	AVANT CHARIOT VITE	ARRIERE CHARIOT VITE	AVANT CHARIOT 1-2 VIT.
ARR. CHARIOT 1-2 VIT.	AVANT PONT	ARRIERE PONT	AVANT PONT VITE	ARRIERE PONT VITE	AVANT PONT 1-2 VIT.	ARRIERE PONT 1-2 VIT.	AVANT TRANSLATION	ARRIERE TRANSLATION	GAUCHE
DROITE	GAUCHE CHARIOT	DROITE CHARIOT	GAUCHE CHARIOT VITE	DROITE CHARIOT VITE	GAUCHE CHARIOT 1-2 VIT.	DROITE CHARIOT 1-2 VIT.	GAUCHE PONT	DROITE PONT	GAUCHE PONT VITE
TREUIL GAUCHE DESC. LENTE	DROITE PONT VITE	GAUCHE PONT 1-2 VIT.	DROITE PONT 1-2 VIT.	GAUCHE ROTATION	DROITE ROTATION	GAUCHE ROTATION VITE	DROITE ROTATION VITE	GAUCHE ROT. 1-2 VIT.	DROITE ROT. 1-2 VIT.
GAUCHE ROT. 3EME VIT.	DROITE ROT. 3EME VIT.	GAUCHE BOITE A BOUTONS	DROITE BOITE A BOUTONS	CHARIOT GAUCHE	CHARIOT DROITE	LENT	VITE	VITE CHARIOT	VITE PONT
VITE LEVAGE	VITE ROTATION	ACCOUPLMNT. TREUIL	OUVRE	FERME	OUVRE PINCE	FERME PINCE	OUVRE BENNE	FERME BENNE	OUVRE PORTAIL
FERME PORTAIL	ACCELERATION	DECELERATION	HISSER	ABAISSE	CHARGE	DECHARGE	EXCITER	DESEXCITER	MAGNETISE
DEMAGNETISE	APPROCHE	CONSEMENT	AUTOMATIQUE	MANUEL	MAN-0-AUTO	OFF-MAN-AUTO	ON	OFF	ON-OFF
IN	OUT	NORD	SUD	EST	OUEST	SURCHARGE	TARE	1-1+2-2	1-2-1+2
1+2	ON-OFF	A-A+B-B							

Label sheet - German

BETRIEB	ALARM	FAHRT ALARM	SPERRE	STOP	LICHT	STROM AN	STROM AUS	GREIFER BETRIEB	GREIFER STOP
BREMSE	ZURUCK	RAUF	RUNTER	HUB RAUF	HUB RUNTER	HUB RAUF 1.-2. GANG	HUB RUNTER 1.-2. GANG	HUB RAUF 3. GANG	HUB RUNTER 3. GANG
HUB SCHNELL RAUF	HUB RUNTER SCHNELL	2. GANG HEBEN	3. GANG HEBEN	HILFSHUB RAUF	HILFSHUB RUNTER	HAUPTHUB RAUF	HAUPTHUB RUNTER	HAUPTHUB RAUF SCH.	HAUPTHUB RUNTER SCH.
HILFSHUB RAUF 1.-2. GANG	HILFSHUB RUNTER 1.-2. GANG	HAUPTHUB 1.-2. GANG	HAUPTHUB RUNTER 1.-2. GANG	WINDE RAUF	WINDE RUNTER	WINDE RAUF 1.-2. GANG	WINDE RUNTER 1.-2. GANG	WINDE RAUF SCHNELL	WINDE RUNTER SCHNELL
WINDE RECHTS LANGS. HOCH	WINDE RECHTS LANGS. RUNTER	WINDE RECHTS SCHNELL RAUF	WINDE RECHTS SCHNELL RUNTER	WINDE LINKS LANGSAM RAUF	WINDE LINKS SCHNELL RAUF	WINDE LINKS SCHNELL RUNTER	FLASCHENZUG HOCH	FLASCHENZUG RUNTER	FLASCHENZUG HOCH 1.-2. GANG
FLASCHENZUG RUNTER 1.-2. GANG	FLASCHENZUG HOCH SCHNELL	FLASCHENZUG RUNTER SCHNELL	VORWÄRTS	RÜCKWÄRTS	LAUFKATZE VORWÄRTS	LAUFKATZE RÜCKWÄRTS	LAUFKATZ VORWÄRTS SCHNELL	LAUFKATZE RÜCKWÄRTS SCHNELL	LAUFKATZE VORW. 1.-2. GANG
LAUFKATZE ZURÜCK 1.-2. GANG	KRANBRUECKE VORWÄRTS	KRANBRUECKE RÜCKWÄRTS	KRANBRUECKE VORW. SCHNELL	KRANBRUECKE RÜCKW. SCHNELL	KRANBRUECKE VORW. 1.-2. GANG	KRANBRUECKE ZUR. 1.-2. GANG	BEWEGUNG VORWÄRTS	BEWEGUNG RÜCKWÄRTS	LINKS
RECHTS	LAUFKATZE - LINKS	LAUFKATZE - RECHTS	LAUFKATZE LINKS SCHNELL	LAUFKATZE RECHTS SCHNELL	LAUFKATZE LINKS 1.-2. GANG	LAUFKATZE RECHTS 1.-2. GANG	KRANBRUECKE RECHTS	KRANBRUECKE LINKS	KRANBRÜCKE LINKS SCHNELL
WINDE LINKS LANGSAM RUNTER	KRANBRÜCKE RECHTS SCHNELL	KRANBRÜCKE LINKS 1.-2. GANG	KRANBRÜCKE RECHTS 1.-2. GANG	DREHUNG LINKS	DREHUNG RECHTS	DREHUNG LINKS SCHNELL	DREHUNG RECHTS SCHNELL	DREHUNG LINKS 1.-2. GANG	DREHUNG RECHTS 1.-2. GANG
DREHUNG LINKS 3. GANG	DREHUNG RECHTS 3. GANG	HÄNGETASTER LINKS	HÄNGETASTER RECHTS	LINKE LAUFKATZE	RECHTE LAUFKATZE	LANGSAM	SCHNELL	LAUFKATZE SCHNELL	KRANBRÜCKE SCHNELL
HEBEN - SCHNELL	DREHUNG - SCHNELL	WINDE PAAREN	OEFFNEN	SCHLIESSEN	ZANGE OEFFNEN	ZANGE SCHLIESSEN	GREIFER OEFFNEN	GREIFER SCHLIESSEN	DECKELÖFFNUNG
DECKELVERSCHLUSS	BESCHLEUNIGEN	VERZÖGERN	ANHEBEN	ABSENKEN	LADUNG	ABLADEN	ERREGEN	ABERREGEN	MAGNETISIERUNG
ENTMAGNETISIEREN	ANNÄHERN	ENTBLOCKKUNG	AUTOMATIK	HANDBETRIEB	HANDBETR. / AUTOMATIK	AUS HANDBETR. / AUTOMATIK	AN	AUS	AN - AUS
REIN	RAUS	NORD	SÜD	OST	WEST	UBERBELASTUNG	TARA	1-1+2-2	1-2-1+2
1+2	ON-OFF	A-A+B-B							

Label sheet - Spanish

MARCHA	ALARMA	MARCHA ALARMA	PARO	STOP	LUZ	MARCHA LINEA	PARO LINEA	MARCHA PALA	PARO PALA
FRENO	RETORNO	SUBIR	BAJAR	SUBIR ELEVACION	BAJAR ELEVACION	SUBIR ELEV. 1-2 VEL.	BAJAR ELEV. 1-2 VEL.	SUBIR ELEV. 3ª VEL.	BAJAR ELEV. 3ª VEL.
SUBIR ELEV. RAPIDA	BAJAR ELEV. RAPIDA	2ª VEL. ELEVACION	3ª VEL. ELEVACION	SUBIR AUX. ELEVACION	BAJAR AUX. ELEVACION	SUBIR ELEV. PRINCIPAL	BAJAR ELEV. PRINCIPAL	SUBIR ELEV. PRINC. RAPIDA	BAJAR ELEV. PRINC. RAPIDA
SUBIR AUX. 1-2 VEL.	BAJAR AUX. 1-2 VEL.	SUBIR PRINC. 1-2 VEL.	BAJAR PRINC. 1-2 VEL.	SUBIR POLIPASTO	BAJAR POLIPASTO	SUBIR POLIP. 1-2 VEL.	BAJAR POLIP. 1-2 VEL.	SUBIR POLIP. RAPIDO	BAJAR POLIP. RAPIDO
POLIP. DER. SUBIR LENTO	POLIP. DER. BAJAR LENTO	POLIP. DER. SUBIR RAPIDO	POLIP. DER. BAJAR RAPIDO	POLIP. IZQ. SUBIR LENTO	POLIP. IZQ. SUBIR RAPIDO	POLIP. IZQ. BAJAR RAPIDO	SUBIR GANCHO	BAJAR GANCHO	SUBIR GANCHO 1-2 VEL.
BAJAR GANCHO 1-2 VEL.	SUBIR GANCHO RAPIDO	BAJAR GANCHO RAPIDO	ADELANTE	ATRAS	ADELANTE CARRITO	ATRAS CARRITO	ADELANTE CARR. RAPIDO	ATRAS CARR. RAPIDO	ADELANTE CARR. 1-2 VEL.
ATRAS CARR. 1-2 VEL.	ADELANTE PUENTE	ATRAS PUENTE	ADELANTE PUENTE RAPIDO	ATRAS PUENTE RAPIDO	ADELANTE PUENTE 1-2 VEL.	ATRAS PUENTE 1-2 VEL.	ADELANTE TRASLACION	ATRAS TRASLACION	IZQUIERDA
DERECHA	IZQUIERDA CARRITO	DERECHA CARRITO	IZQUIERDA CARR. RAPIDO	DERECHA CARR. RAPIDO	IZQUIERDA CARR. 1-2 VEL.	DERECHA CARR. 1-2 VEL.	IZQUIERDA PUENTE	DERECHA PUENTE	IZQUIERDA PUENTE RAPIDO
POLIP. IZQUIER. BAJAR LENTO	DERECHA PUENTE RAPIDO	IZQUIERDA PUENTE 1-2 VEL.	DERECHA PUENTE 1-2VEL.	IZQUIERDA ROTACION	DERECHA ROTACION	IZQUIERDA ROT. RAPIDA	DERECHA ROT. RAPIDA	IZQUIERDA ROT. 1-2 VEL.	DERECHA ROT. 1-2 VEL.
IZQUIERDA ROT. 3ª VEL.	DERECHA ROT. 3ª VEL.	BOTONERA IZQUIERDA	BOTONERA DERECHA	CARRITO IZQUIERDO	CARRITO DERECHO	LENTO	RAPIDO	CARRITO RAPIDO	PUENTE RAPIDO
ELEVACION RAPIDA	ROTACION RAPIDA	ACOPLAMIENTO POLIPASTO	ABRIR	CERRAR	ABRIR PINZA	CERRAR PINZA	ABRIR PALA	CERRAR PALA	ABRIR PUERTA
CERRAR PUERTA	ACELERAR	DESACELERAR	ELEVAR	DESCENDER	CARGAR	DESCARGAR	IMANTAR	DESIMANTAR	IMANTAR MAGNETO
DESIMANTAR MAGNETO	ACERCAR	CONFIRMAR	AUTOMATICO	MANUAL	MAN-0-AUTO	OFF-MAN-AUTO	ON	OFF	ON-OFF
IN	OUT	NORTE	SUR	ESTE	OESTE	SOBRECARGA	TARA	1-1+2-2	1-2-1+2
1+2	ON-OFF	A-A+B-B							

MIKE - REQUEST FORM FOR NON STANDARD PENDANT STATION

Instructions

(See next page for list of components and legends)

Fill in the chart according to the number of control elements required. Control stations are available with enclosures from 4 to 15 control elements. It is possible to assemble a control element on the bottom of the control station only with enclosures with an odd number of holes.

- 1 Control elements:** enter the number corresponding to the control element required (1 to 39) according to the legend. Eg. 25
- 2 Button disks:** for pushbuttons (1 to 3) enter the number corresponding to the disk required (50 to 85) according to the legend. Both full color disks and transparent disks (for illuminated buttons) are available. Eg. 57
- 3 Color of selectors, mushrooms, pilot lights:** for toggle selector switches (15 to 24), impulse mushroom pushbuttons (7) and pilot lights (11) enter the code corresponding to the color required according to the legend. Eg. RP
- 4** If you choose disks with arrows (legend 54 to 72), enter the direction of the arrow in the circle. Eg. ↗
- 5 Switches, LEDs and potentiometers:** enter the number corresponding to the switch, LED or potentiometer required (90 to 93) according to the legend. It is possible to enter up to 3 switches per position. Es. 91
2 speed pushbuttons can activate two switches on the first speed and one switch on the second speed.
Selector switches can activate only two switches and possibly a LED.
ATTENTION: LEDs can be placed only in the central position and they are used for illuminated buttons and selector switches.
(See Control Element legend for switch activation)
- 6 Hook:** tick the box at the top or at the bottom if the hook is required. Eg. Hook
- 7 Cable sleeve and cable clamp:** tick the box if the cable sleeve or the cable clamp are required.
Eg. Sleeve
- 8 Mechanical interlock and ON-OFF actuator:** tick the boxes where the mechanical interlock (MI) between two control elements or the latched ON-OFF change-over actuator (LA) is required. Eg. MI
- 9 Protection:** when a control element is mounted on the bottom of the control station, it is possible to use a protection; in this case tick the box corresponding to the protection required. Eg. Small
- 10 Cover:** tick the box corresponding to the cover color required (the base of the enclosure is always black).
- 11 SIL 1 certified:** tick the box if you require SIL 1 certified units.
- 12 Label sheet:** stickers with letterings or symbols may be placed on the left and on the right of any control element. If label sheets are required, tick the corresponding box.
- 13 cULus certified:** tick the box if you require cULus certified units.

Control element on the bottom of the control station*

<input type="checkbox"/>	Control element	1		
<input type="checkbox"/>	Color	3		
<input type="checkbox"/>	Switches	5		
<input type="checkbox"/> Small	<input type="checkbox"/> Large	<input type="checkbox"/> None	Protection	9

*ATTENTION: only mushroom pushbuttons with ref. 4, 5, 6 with one or two switches, or **non illuminated** selector switches ref. 15, 16, 30, 31 with only one switch can be assembled on the bottom of the control station. LEDs can not be mounted in this position.

Cover 10	<input type="checkbox"/> Yellow	<input type="checkbox"/> Black	SIL 1 certified 11	<input type="checkbox"/>
Label sheet 12	<input type="checkbox"/> Symbols	<input type="checkbox"/> English	<input type="checkbox"/> French	cULus certified 13
	<input type="checkbox"/> Italian	<input type="checkbox"/> German	<input type="checkbox"/> Spanish	

1 Control elements	2 Button disks	3 Color of selectors, mushrooms, pilot lights	4	5 Switches and LEDs	6 Hook	7 Cable sleeve	8 MI	8 LA	9	10	11	12	13
<input type="checkbox"/>	<input type="checkbox"/>	<input type="checkbox"/>	<input type="checkbox"/>	<input type="checkbox"/>	<input type="checkbox"/>	<input type="checkbox"/>							
<input type="checkbox"/>	<input type="checkbox"/>	<input type="checkbox"/>	<input type="checkbox"/>	<input type="checkbox"/>	<input type="checkbox"/>	<input type="checkbox"/>							
<input type="checkbox"/>	<input type="checkbox"/>	<input type="checkbox"/>	<input type="checkbox"/>	<input type="checkbox"/>	<input type="checkbox"/>	<input type="checkbox"/>							
<input type="checkbox"/>	<input type="checkbox"/>	<input type="checkbox"/>	<input type="checkbox"/>	<input type="checkbox"/>	<input type="checkbox"/>	<input type="checkbox"/>							
<input type="checkbox"/>	<input type="checkbox"/>	<input type="checkbox"/>	<input type="checkbox"/>	<input type="checkbox"/>	<input type="checkbox"/>	<input type="checkbox"/>							
<input type="checkbox"/>	<input type="checkbox"/>	<input type="checkbox"/>	<input type="checkbox"/>	<input type="checkbox"/>	<input type="checkbox"/>	<input type="checkbox"/>							
<input type="checkbox"/>	<input type="checkbox"/>	<input type="checkbox"/>	<input type="checkbox"/>	<input type="checkbox"/>	<input type="checkbox"/>	<input type="checkbox"/>							
<input type="checkbox"/>	<input type="checkbox"/>	<input type="checkbox"/>	<input type="checkbox"/>	<input type="checkbox"/>	<input type="checkbox"/>	<input type="checkbox"/>							
<input type="checkbox"/>	<input type="checkbox"/>	<input type="checkbox"/>	<input type="checkbox"/>	<input type="checkbox"/>	<input type="checkbox"/>	<input type="checkbox"/>							
<input type="checkbox"/>	<input type="checkbox"/>	<input type="checkbox"/>	<input type="checkbox"/>	<input type="checkbox"/>	<input type="checkbox"/>	<input type="checkbox"/>							
<input type="checkbox"/>	<input type="checkbox"/>	<input type="checkbox"/>	<input type="checkbox"/>	<input type="checkbox"/>	<input type="checkbox"/>	<input type="checkbox"/>							
<input type="checkbox"/>	<input type="checkbox"/>	<input type="checkbox"/>	<input type="checkbox"/>	<input type="checkbox"/>	<input type="checkbox"/>	<input type="checkbox"/>							
<input type="checkbox"/>	<input type="checkbox"/>	<input type="checkbox"/>	<input type="checkbox"/>	<input type="checkbox"/>	<input type="checkbox"/>	<input type="checkbox"/>							
<input type="checkbox"/>	<input type="checkbox"/>	<input type="checkbox"/>	<input type="checkbox"/>	<input type="checkbox"/>	<input type="checkbox"/>	<input type="checkbox"/>							
<input type="checkbox"/>	<input type="checkbox"/>	<input type="checkbox"/>	<input type="checkbox"/>	<input type="checkbox"/>	<input type="checkbox"/>	<input type="checkbox"/>							
<input type="checkbox"/>	<input type="checkbox"/>	<input type="checkbox"/>	<input type="checkbox"/>	<input type="checkbox"/>	<input type="checkbox"/>	<input type="checkbox"/>							
<input type="checkbox"/>	<input type="checkbox"/>	<input type="checkbox"/>	<input type="checkbox"/>	<input type="checkbox"/>	<input type="checkbox"/>	<input type="checkbox"/>							
<input type="checkbox"/>	<input type="checkbox"/>	<input type="checkbox"/>	<input type="checkbox"/>	<input type="checkbox"/>	<input type="checkbox"/>	<input type="checkbox"/>							
<input type="checkbox"/>	<input type="checkbox"/>	<input type="checkbox"/>	<input type="checkbox"/>	<input type="checkbox"/>	<input type="checkbox"/>	<input type="checkbox"/>							
<input type="checkbox"/>	<input type="checkbox"/>	<input type="checkbox"/>	<input type="checkbox"/>	<input type="checkbox"/>	<input type="checkbox"/>	<input type="checkbox"/>							
<input type="checkbox"/>	<input type="checkbox"/>	<input type="checkbox"/>	<input type="checkbox"/>	<input type="checkbox"/>	<input type="checkbox"/>	<input type="checkbox"/>							
<input type="checkbox"/>	<input type="checkbox"/>	<input type="checkbox"/>	<input type="checkbox"/>	<input type="checkbox"/>	<input type="checkbox"/>	<input type="checkbox"/>							
<input type="checkbox"/>	<input type="checkbox"/>	<input type="checkbox"/>	<input type="checkbox"/>	<input type="checkbox"/>	<input type="checkbox"/>	<input type="checkbox"/>							
<input type="checkbox"/>	<input type="checkbox"/>	<input type="checkbox"/>	<input type="checkbox"/>	<input type="checkbox"/>	<input type="checkbox"/>	<input type="checkbox"/>							
<input type="checkbox"/>	<input type="checkbox"/>	<input type="checkbox"/>	<input type="checkbox"/>	<input type="checkbox"/>	<input type="checkbox"/>	<input type="checkbox"/>							
<input type="checkbox"/>	<input type="checkbox"/>	<input type="checkbox"/>	<input type="checkbox"/>	<input type="checkbox"/>	<input type="checkbox"/>	<input type="checkbox"/>							
<input type="checkbox"/>	<input type="checkbox"/>	<input type="checkbox"/>	<input type="checkbox"/>	<input type="checkbox"/>	<input type="checkbox"/>	<input type="checkbox"/>							
<input type="checkbox"/>	<input type="checkbox"/>	<input type="checkbox"/>	<input type="checkbox"/>	<input type="checkbox"/>	<input type="checkbox"/>	<input type="checkbox"/>							
<input type="checkbox"/>	<input type="checkbox"/>	<input type="checkbox"/>	<input type="checkbox"/>	<input type="checkbox"/>	<input type="checkbox"/>	<input type="checkbox"/>							
<input type="checkbox"/>	<input type="checkbox"/>	<input type="checkbox"/>	<input type="checkbox"/>	<input type="checkbox"/>	<input type="checkbox"/>	<input type="checkbox"/>							
<input type="checkbox"/>	<input type="checkbox"/>	<input type="checkbox"/>	<input type="checkbox"/>	<input type="checkbox"/>	<input type="checkbox"/>	<input type="checkbox"/>							
<input type="checkbox"/>	<input type="checkbox"/>	<input type="checkbox"/>	<input type="checkbox"/>	<input type="checkbox"/>	<input type="checkbox"/>	<input type="checkbox"/>							
<input type="checkbox"/>	<input type="checkbox"/>	<input type="checkbox"/>	<input type="checkbox"/>	<input type="checkbox"/>	<input type="checkbox"/>	<input type="checkbox"/>							
<input type="checkbox"/>	<input type="checkbox"/>	<input type="checkbox"/>	<input type="checkbox"/>	<input type="checkbox"/>	<input type="checkbox"/>	<input type="checkbox"/>							
<input type="checkbox"/>	<input type="checkbox"/>	<input type="checkbox"/>	<input type="checkbox"/>	<input type="checkbox"/>	<input type="checkbox"/>	<input type="checkbox"/>							
<input type="checkbox"/>	<input type="checkbox"/>	<input type="checkbox"/>	<input type="checkbox"/>	<input type="checkbox"/>	<input type="checkbox"/>	<input type="checkbox"/>							
<input type="checkbox"/>	<input type="checkbox"/>	<input type="checkbox"/>	<input type="checkbox"/>	<input type="checkbox"/>	<input type="checkbox"/>	<input type="checkbox"/>							
<input type="checkbox"/>	<input type="checkbox"/>	<input type="checkbox"/>	<input type="checkbox"/>	<input type="checkbox"/>	<input type="checkbox"/>	<input type="checkbox"/>							
<input type="checkbox"/>	<input type="checkbox"/>	<input type="checkbox"/>	<input type="checkbox"/>	<input type="checkbox"/>	<input type="checkbox"/>	<input type="checkbox"/>							
<input type="checkbox"/>	<input type="checkbox"/>	<input type="checkbox"/>	<input type="checkbox"/>	<input type="checkbox"/>	<input type="checkbox"/>	<input type="checkbox"/>							
<input type="checkbox"/>	<input type="checkbox"/>	<input type="checkbox"/>	<input type="checkbox"/>	<input type="checkbox"/>	<input type="checkbox"/>	<input type="checkbox"/>							
<input type="checkbox"/>	<input type="checkbox"/>	<input type="checkbox"/>	<input type="checkbox"/>	<input type="checkbox"/>	<input type="checkbox"/>	<input type="checkbox"/>							
<input type="checkbox"/>	<input type="checkbox"/>	<input type="checkbox"/>	<input type="checkbox"/>	<input type="checkbox"/>	<input type="checkbox"/>	<input type="checkbox"/>							
<input type="checkbox"/>	<input type="checkbox"/>	<input type="checkbox"/>	<input type="checkbox"/>	<input type="checkbox"/>	<input type="checkbox"/>	<input type="checkbox"/>							
<input type="checkbox"/>	<input type="checkbox"/>	<input type="checkbox"/>	<input type="checkbox"/>	<input type="checkbox"/>	<input type="checkbox"/>	<input type="checkbox"/>							
<input type="checkbox"/>	<input type="checkbox"/>	<input type="checkbox"/>	<input type="checkbox"/>	<input type="checkbox"/>	<input type="checkbox"/>	<input type="checkbox"/>							
<input type="checkbox"/>	<input type="checkbox"/>	<input type="checkbox"/>	<input type="checkbox"/>	<input type="checkbox"/>	<input type="checkbox"/>	<input type="checkbox"/>							
<input type="checkbox"/>	<input type="checkbox"/>	<input type="checkbox"/>	<input type="checkbox"/>	<input type="checkbox"/>	<input type="checkbox"/>	<input type="checkbox"/>							
<input type="checkbox"/>	<input type="checkbox"/>	<input type="checkbox"/>	<input type="checkbox"/>	<input type="checkbox"/>	<input type="checkbox"/>	<input type="checkbox"/>							
<input type="checkbox"/>	<input type="checkbox"/>	<input type="checkbox"/>	<input type="checkbox"/>	<input type="checkbox"/>	<input type="checkbox"/>	<input type="checkbox"/>							
<input type="checkbox"/>	<input type="checkbox"/>	<input type="checkbox"/>	<input type="checkbox"/>	<input type="checkbox"/>	<input type="checkbox"/>	<input type="checkbox"/>							
<input type="checkbox"/>	<input type="checkbox"/>	<input type="checkbox"/>	<input type="checkbox"/>	<input type="checkbox"/>	<input type="checkbox"/>	<input type="checkbox"/>							
<input type="checkbox"/>	<input type="checkbox"/>	<input type="checkbox"/>	<input type="checkbox"/>	<input type="checkbox"/>	<input type="checkbox"/>	<input type="checkbox"/>							
<input type="checkbox"/>	<input type="checkbox"/>	<input type="checkbox"/>	<input type="checkbox"/>	<input type="checkbox"/>	<input type="checkbox"/>	<input type="checkbox"/>							
<input type="checkbox"/>	<input type="checkbox"/>	<input type="checkbox"/>	<input type="checkbox"/>	<input type="checkbox"/>	<input type="checkbox"/>	<input type="checkbox"/>							
<input type="checkbox"/>	<input type="checkbox"/>	<input type="checkbox"/>	<input type="checkbox"/>	<input type="checkbox"/>	<input type="checkbox"/>	<input type="checkbox"/>							
<input type="checkbox"/>	<input type="checkbox"/>	<input type="checkbox"/>	<input type="checkbox"/>	<input type="checkbox"/>	<input type="checkbox"/>	<input type="checkbox"/>							
<input type="checkbox"/>	<input type="checkbox"/>	<input type="checkbox"/>	<input type="checkbox"/>	<input type="checkbox"/>	<input type="checkbox"/>	<input type="checkbox"/>							
<input type="checkbox"/>	<input type="checkbox"/>	<input type="checkbox"/>	<input type="checkbox"/>	<input type="checkbox"/>	<input type="checkbox"/>	<input type="checkbox"/>							
<input type="checkbox"/>	<input type="checkbox"/>	<input type="checkbox"/>	<input type="checkbox"/>	<input type="checkbox"/>	<input type="checkbox"/>	<input type="checkbox"/>							
<input type="checkbox"/>	<input type="checkbox"/>	<input type="checkbox"/>	<input type="checkbox"/>	<input type="checkbox"/>	<input type="checkbox"/>	<input type="checkbox"/>							
<input type="checkbox"/>	<input type="checkbox"/>	<input type="checkbox"/>	<input type="checkbox"/>	<input type="checkbox"/>	<input type="checkbox"/>	<input type="checkbox"/>							
<input type="checkbox"/>	<input type="checkbox"/>	<input type="checkbox"/>	<input type="checkbox"/>	<input type="checkbox"/>	<input type="checkbox"/>	<input type="checkbox"/>							
<input type="checkbox"/>	<input type="checkbox"/>	<input type="checkbox"/>	<input type="checkbox"/>	<input type="checkbox"/>	<input type="checkbox"/>	<input type="checkbox"/>							
<input type="checkbox"/>	<input type="checkbox"/>	<input type="checkbox"/>	<input type="checkbox"/>	<input type="checkbox"/>	<input type="checkbox"/>	<input type="checkbox"/>							
<input type="checkbox"/>	<input type="checkbox"/>	<input type="checkbox"/>	<input type="checkbox"/>	<input type="checkbox"/>	<input type="checkbox"/>	<input type="checkbox"/>							
<input type="checkbox"/>	<input type="checkbox"/>	<input type="checkbox"/>	<input type="checkbox"/>	<input type="checkbox"/>	<input type="checkbox"/>	<input type="checkbox"/>							
<input type="checkbox"/>	<input type="checkbox"/>	<input type="checkbox"/>	<input type="checkbox"/>	<input type="checkbox"/>	<input type="checkbox"/>	<input type="checkbox"/>							
<input type="checkbox"/>	<input type="checkbox"/>	<input type="checkbox"/>	<input type="checkbox"/>	<input type="checkbox"/>	<input type="checkbox"/>	<input type="checkbox"/>							
<input type="checkbox"/>	<input type="checkbox"/>	<input type="checkbox"/>	<input type="checkbox"/>	<input type="checkbox"/>	<input type="checkbox"/>	<input type="checkbox"/>							
<input type="checkbox"/>	<input type="checkbox"/>	<input type="checkbox"/>	<input type="checkbox"/>	<input type="checkbox"/>	<input type="checkbox"/>	<input type="checkbox"/>							
<input type="checkbox"/>	<input type="checkbox"/>	<input type="checkbox"/>	<input type="checkbox"/>	<input type="checkbox"/>	<input type="checkbox"/>	<input type="checkbox"/>							
<input type="checkbox"/>	<input type="checkbox"/>	<input type="checkbox"/>	<input type="checkbox"/>	<input type="checkbox"/>	<input type="checkbox"/>	<input type="checkbox"/>							
<input type="checkbox"/>	<input type="checkbox"/>	<input type="checkbox"/>	<input type="checkbox"/>	<input type="checkbox"/>	<input type="checkbox"/>	<input type="checkbox"/>							
<input type="checkbox"/>	<input type="checkbox"/>	<input type="checkbox"/>	<input type="checkbox"/>	<input type="checkbox"/>	<input type="checkbox"/>	<input type="checkbox"/>							
<input type="checkbox"/>	<input type="checkbox"/>	<input type="checkbox"/>	<input type="checkbox"/>	<input type="checkbox"/>	<input type="checkbox"/>	<input type="checkbox"/>							
<input type="checkbox"/>	<input type="checkbox"/>	<input type="checkbox"/>	<input type="checkbox"/>	<input type="checkbox"/>	<input type="checkbox"/>	<input type="checkbox"/>							
<input type="checkbox"/>	<input type="checkbox"/>	<input type="checkbox"/>	<input type="checkbox"/>	<input type="checkbox"/>	<input type="checkbox"/>	<input type="checkbox"/>							
<input type="checkbox"/>	<input type="checkbox"/>	<input type="checkbox"/>	<input type="checkbox"/>	<input type="checkbox"/>	<input type="checkbox"/>	<input type="checkbox"/>							
<input type="checkbox"/>	<input type="checkbox"/>	<input type="checkbox"/>	<input type="checkbox"/>	<input type="checkbox"/>	<input type="checkbox"/>	<input type="checkbox"/>							
<input type="checkbox"/>	<input type="checkbox"/>	<input type="checkbox"/>	<input type="checkbox"/>	<input type="checkbox"/>	<input type="checkbox"/>	<input type="checkbox"/>							
<input type="checkbox"/>	<input type="checkbox"/>	<input type="checkbox"/>	<input type="checkbox"/>	<input type="checkbox"/>	<input type="checkbox"/>	<input type="checkbox"/>							
<input type="checkbox"/>	<input type="checkbox"/>	<input type="checkbox"/>	<input type="checkbox"/>	<input type="checkbox"/>	<input type="checkbox"/>	<input type="checkbox"/>							
<input type="checkbox"/>	<input type="checkbox"/>	<input type="checkbox"/>	<input type="checkbox"/>	<input type="checkbox"/>	<input type="checkbox"/>	<input type="checkbox"/>							
<input type="checkbox"/>	<input type="checkbox"/>	<input type="checkbox"/>	<input type="checkbox"/>	<input type="checkbox"/>	<input type="checkbox"/>	<input type="checkbox"/>							
<input type="checkbox"/>	<input type="checkbox"/>	<input type="checkbox"/>	<input type="checkbox"/>	<input type="checkbox"/>	<input type="checkbox"/>	<input type="checkbox"/>							
<input type="checkbox"/>	<input type="checkbox"/>	<input type="checkbox"/>	<input type="checkbox"/>	<input type="checkbox"/>	<input type="checkbox"/>	<input type="checkbox"/>							
<input type="checkbox"/>	<input type="checkbox"/>	<input type="checkbox"/>	<input type="checkbox"/>	<input type="checkbox"/>	<input type="checkbox"/>	<input type="checkbox"/>							
<input type="checkbox"/>	<input type="checkbox"/>	<input type="checkbox"/>	<input type="checkbox"/>	<input type="checkbox"/>	<input type="checkbox"/>	<input type="checkbox"/>							
<input type="checkbox"/>	<input type="checkbox"/>	<input type="checkbox"/>	<input type="checkbox"/>	<input type="checkbox"/>	<input type="checkbox"/>	<input type="checkbox"/>							
<input type="checkbox"/>	<input type="checkbox"/>	<input type="checkbox"/>	<input type="checkbox"/>	<input type="checkbox"/>	<input type="checkbox"/>	<input type="checkbox"/>							
<input type="checkbox"/>	<input type="checkbox"/>	<input type="checkbox"/>	<input type="checkbox"/>	<input type="checkbox"/>	<input type="checkbox"/>	<input type="checkbox"/>							
<input type="checkbox"/>	<input type="checkbox"/>	<input type="checkbox"/>	<input type="checkbox"/>	<input type="checkbox"/>	<input type="checkbox"/>	<input type="checkbox"/>							
<input type="checkbox"/>	<input type="checkbox"/>	<input type="checkbox"/>	<input type="checkbox"/>	<input type="checkbox"/>	<input type="checkbox"/>	<input type="checkbox"/>							
<input type="checkbox"/>	<input type="checkbox"/>	<input type="checkbox"/>											

1 Legend - Control elements

* SWITCH ACTIVATION

It is possible to mount up to 3 switches for each control element. The chart on the right of each pushbutton or selector switch specifies which position activates the switch on the top, in the middle or on the bottom. If the selector switches are mounted with the lever facing downwards, then the activation of the switches is reversed. Eg.: 2 speed pushbutton: the first speed activates the switches on the top and in the middle, while the second speed activates the switch on the bottom.

Pushbuttons

It is possible to mount up to three switches for each button. LEDs can be mounted only in the middle.

		SWITCH ACTIVATION*
1	1 speed pushbutton with disk	<input type="checkbox"/> speed 1
25	1 speed black pushbutton	<input type="checkbox"/> speed 1
26	1 speed grey pushbutton	<input type="checkbox"/> speed 1
2	2 speed pushbutton with disk	<input type="checkbox"/> speed 1 <input type="checkbox"/> speed 2
27	2 speed black pushbutton	<input type="checkbox"/> speed 1 <input type="checkbox"/> speed 2
28	2 speed grey pushbutton	<input type="checkbox"/> speed 1 <input type="checkbox"/> speed 2
3	1 speed illuminated pushbutton with disk	<input type="checkbox"/> speed 1 <input type="checkbox"/> LED <input type="checkbox"/> speed 1

Mushroom pushbuttons

All mushroom pushbuttons activate all the switches at the same time.

4	Latched mushroom pushbutton for emergency stop
5	Latched mushroom pushbutton for emergency stop Ø 40 mm
6	Key mushroom pushbutton
7	Impulse mushroom pushbutton Ø 33 mm with black base

11 Pilot light

12 Blanking plug

Toggle selector switches

It is possible to mount only two switches for each selector. In the middle it is possible to mount only the LED for illuminated selector switches.

		SWITCH ACTIVATION*
15	0/1 spring return	<input type="checkbox"/> pos 1
16	0/1 maintained positions	<input type="checkbox"/> pos 1
17	1/0/2 spring return	<input type="checkbox"/> pos 1 <input type="checkbox"/> pos 2
18	1/0/2 maintained positions	<input type="checkbox"/> pos 1 <input type="checkbox"/> pos 2
19	1/1+2/2 spring return	<input type="checkbox"/> pos 1 and 1+2 <input type="checkbox"/> pos 2 and 1+2
20	1/1+2/2 maintained positions	<input type="checkbox"/> pos 1 and 1+2 <input type="checkbox"/> pos 2 and 1+2
21	0/1/1+2 spring return	<input type="checkbox"/> pos 1+2 <input type="checkbox"/> pos 1 and 1+2
22	0/1/1+2 maintained positions	<input type="checkbox"/> pos 1+2 <input type="checkbox"/> pos 1 and 1+2
23	1/2 spring return	<input type="checkbox"/> pos 1 <input type="checkbox"/> pos 2
24	1/2 maintained positions	<input type="checkbox"/> pos 1 <input type="checkbox"/> pos 2

Key selector switches

It is possible to mount only two switches for each selector, and no switch/LED in the central position.

		SWITCH ACTIVATION*
30	0/1 spring return key out in position 0	<input type="checkbox"/> pos 1 <input type="checkbox"/> NA <input type="checkbox"/> pos 1
31	0/1 maintained positions key out in position 0	<input type="checkbox"/> pos 1 <input type="checkbox"/> NA <input type="checkbox"/> pos 1
32	1/0/2 spring return key out in position 0	<input type="checkbox"/> pos 1 <input type="checkbox"/> NA <input type="checkbox"/> pos 2
33	1/0/2 maintained positions key out in position 0	<input type="checkbox"/> pos 1 <input type="checkbox"/> NA <input type="checkbox"/> pos 2
34	0/1/1+2 spring return key out in position 0	<input type="checkbox"/> pos 1+2 <input type="checkbox"/> NA <input type="checkbox"/> pos 1 and 1+2
35	0/1/1+2 maintained positions key out in position 0	<input type="checkbox"/> pos 1+2 <input type="checkbox"/> NA <input type="checkbox"/> pos 1 and 1+2
36	1/2 change over spring return key out in position 1	<input type="checkbox"/> pos 1 <input type="checkbox"/> NA <input type="checkbox"/> pos 2
37	1/2 change over maintained positions key out in position 1	<input type="checkbox"/> pos 1 <input type="checkbox"/> NA <input type="checkbox"/> pos 2
38	1/1+2/2 spring return key out in position 1+2	<input type="checkbox"/> pos 1 and 1+2 <input type="checkbox"/> NA <input type="checkbox"/> pos 2 and 1+2
39	1/1+2/2 maintained positions key out in position 1+2	<input type="checkbox"/> pos 1 and 1+2 <input type="checkbox"/> NA <input type="checkbox"/> pos 2 and 1+2

2 Legend - Button disks

Full color and symbol disks for pushbuttons (ref. 1 and 2)

50	GREEN	55	RED	60	RED	65	RED	70	RED	75	RED	77	RED
51	RED	56	RED	61	RED	66	RED	71	BLUE	76	YELLOW	78	BLUE
52	YELLOW	57	YELLOW	62	YELLOW	67	YELLOW	72	YELLOW	77	WHITE	79	ORANGE
53	GREEN	58	GREEN	63	GREEN	68	GREEN	73	GREY	75	BLACK		
54	GREEN	59	GREEN	64	GREEN	69	GREEN	74	OPEN	76	GREEN		

Transparent disks for illuminated buttons (ref. 3)

80	YELLOW	82	WHITE	84	GREEN
81	RED	83	BLUE	85	ORANGE

3 Legend - Color of selectors, mushrooms, pilot lights

Non-illuminated toggle selector switches (ref. 15 to 24)

RP	Red	BP	Blue	AP	Orange
GP	Yellow	VP	Green	WP	White

Impulse mushroom pushbutton with black base (ref. 7)

R	Red	B	Blue	A	Orange
G	Yellow	V	Green	N	Black

Illuminated toggle selector switches (ref. 15 to 24)

RI	Red	BI	Blue	AI	Orange
GI	Yellow	VI	Green	WI	White

Pilot lights (ref. 11)

R	Red	B	Blue	A	Orange
G	Yellow	V	Green	W	White

5 Legend - Switches, LEDs, potentiometers

90	PRSL1800PI - 1NO switch
91	PRSL1801PI - 1NC switch
92	PRSL1820PI LED 24/48 Vac/dc
93	PRSL1821PI LED 110/230 Vac
94	PRSL1891PI potentiometer 4.7 kΩ
95	PRSL1892PI potentiometer 10 kΩ
96	PRSL1893PI potentiometer 1 kΩ

USE AND MAINTENANCE INSTRUCTIONS

Mike Pendant Control Station is an electromechanical device for low voltage control circuits (EN 60947-1, EN 60947-5-1) to be used as electrical equipment on machines (EN 60204-1) in compliance with the fundamental requirements of the Low Voltage Directive 2014/35/UE and of the Machine Directive 2006/42/CE.

The pendant station is designed for industrial use and also for use under particularly severe climatic conditions (operational temperature from -40°C to $+80^{\circ}\text{C}$, suitable for use in tropical environment).

The equipment is not suitable for use in environments with potentially explosive atmosphere, corrosive agents or a high percentage of sodium chloride (saline fog). Oils, acids or solvents may damage the equipment; avoid using them for cleaning.

Do not connect more than one phase to each switch. Do not oil or grease the control elements or the switches.

The installation of the pendant station shall be carried out by expert and trained personnel. Wiring shall be properly done according to the current instructions.

Prior to the installation and the maintenance of the pendant station, the main power of the machinery shall be turned off.

Steps for the proper installation of the pendant station

- Open the pendant station.
- Screw the variable section rubber cable sleeve (6) onto the enclosure (14).
- Cut the cable sleeve (6) and insert the multi-pole cable tight enough to guarantee protection against water and/or dust.
- Strip the cable to a length suitable for wiring the switches/LED (10).
- Tape the stripped part of the cable.
- Fix the multi-pole cable inside the pendant station using the variable section cable clamp (9) (supplied together with the fixing screws (8), inside the "Accessories bag").
- Tighten the cable tie (15) (inside the "Accessories bag") under the chosen measure ring on the cable sleeve (6).
- Connect all the switches/LED (10) according to the wiring layout printed on the switches /LED and overleaf (tighten the wires into the terminals with a torque equal to 0.5 Nm; (UL (c)UL: use 60°C or 75°C copper (CU) conductors and stiff or flexible wire 14-22 AWG); insertability of wires into the terminals $2 \times 0.5 \text{ mm}^2$ $2 \times 1.5 \text{ mm}^2$ $1 \times 2.5 \text{ mm}^2$).
- Close the pendant station checking the proper positioning of the tightening gasket (13), making sure the gasket fits well into the cover and the enclosure seats.

ATTENTION: make sure no cable is in between the switches/LED (10) and the actuators (16) mounted on the upper cover (11). Fix the closing clips (12), if provided and depending on the assembly. Tighten the fixing screws (3) on the cover with a torque of 250 cNm.

- Screw the clamping plates (4, 5) into their seat on the enclosure (14).
- Fasten the holding wires, used to support the multi-pole cable, to the clamping plates (4, 5). ATTENTION: make sure the holding wires are as close as possible to the screw. After positioning the holding wires, tighten the screw.
- Position the wire cover (2) and tighten the screw (1) with a torque of 250 cNm. Insert the hook (7) into its seats on the enclosure (14).
- In order to open the control station, loosen the screws on the cover (3), remove the clips (12), if provided, loosen the screw (1) and remove the wire cover (2), and loosen the clamping plate (4).

ATTENTION: Do not operate on the pushbuttons when the control station is not perfectly closed (with screws tightened and clips fitted as described in point 9) as this may cause the release of the mechanical interlock. If this happens, re-position the mechanical interlock before closing the control station.

Periodic maintenance steps

- Check the proper tightening of the screws (3) of the enclosure (11, 14).
- Check the proper tightening of the switch/LED (10) terminal screws.
- Check the wiring conditions (in particular where wires clamp into the switches).
- Check the conditions of the tightening gasket (13), of the rubber of the actuators (16) and of the cable sleeve (6).
- Check that the plastic enclosure (11, 14) of the pendant station is not broken.
- Check the proper assembling of the clips (12), if provided.

In case any component of the pendant station is modified, the validity of the markings and the guarantee on the equipment are annulled. Should any component need replacement, use original spare parts only.

TER declines all responsibility for damages caused by the improper use or installation of the equipment.

UL Specifications

UL Technical Specifications

UL certified Mike Code = F80XXXXXXXXXXXXXX

Category = NKCR / NKCR7

Switch Rating = A600, Q600

LED PRSL1821PI Rating = 110 – 240Vac, 1.15 – 2.50 mA

LED PRSL1820PI Rating = 24 – 48 Vdc/ac, 1.30 – 2.70 mA

Environmental Rating (Mike black) = Type 1, 4 and 4X

Environmental Rating (Mike yellow) = Type 1, 4 and 4X indoor use only

Cord diameter range = from 0.31 in (8mm) to 0.91 in (23mm)

Cord type = flexible, type minimum SW or SJW (ZJCZ/7)

Wire size range = 14-22 AWG stranded or solid

Conductors = Copper (CU) 60/75°C

Terminal tightening torque = 4.50 lb.in (0.5Nm)

Marking = 

Protection PRSL1830PI, PRSL1831PI

When the pilot light / selector switch / key selector switch / impulse mushroom pushbutton / mushroom push-button / emergency mushroom push-button / emergency key mushroom push-button / actuator is mounted on the bottom of the enclosed pendant control stations, the large protection PRSL1831PI or small protection PRSL1830PI shall be used.

Emergency Stop Button

Category = NISD3

Code = PRSL1880P1, PRSL1881PI

Switch = PRSL1801PI (A600, Q600)

Optional Switch = PRSL1800PI (A600, Q600)

Code = PRSL1890PI

Switch = PRSL1801PI (A600, Q600)

These unlisted components "emergency stop buttons" are intended for use within TECNO ELETTRICA RAVASI S.R.L. Listed (NKCR) Mike and Victor pushbutton stations.

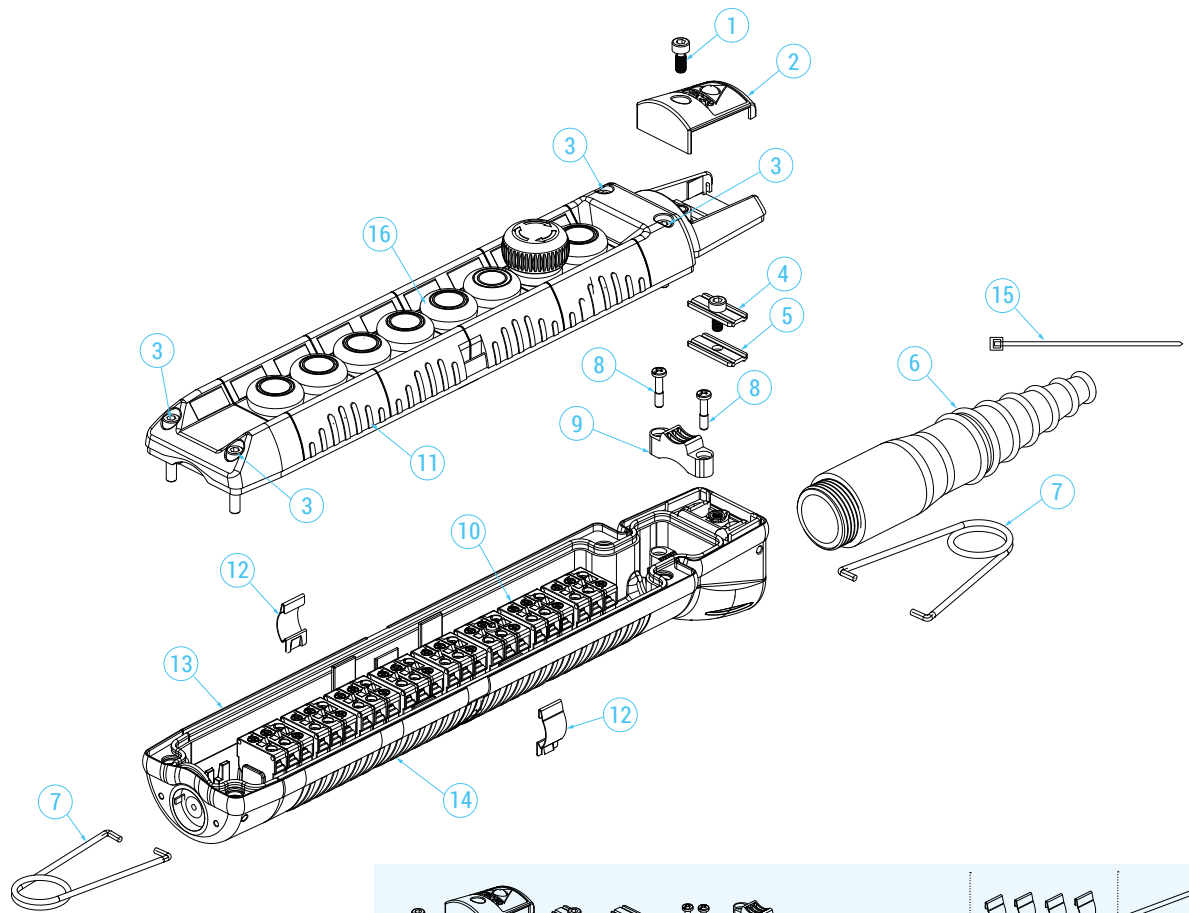

Accessory bag

* Presence and quantity based on model
 ** Optional

Switch activation

